

Complete solutions
on rock tools

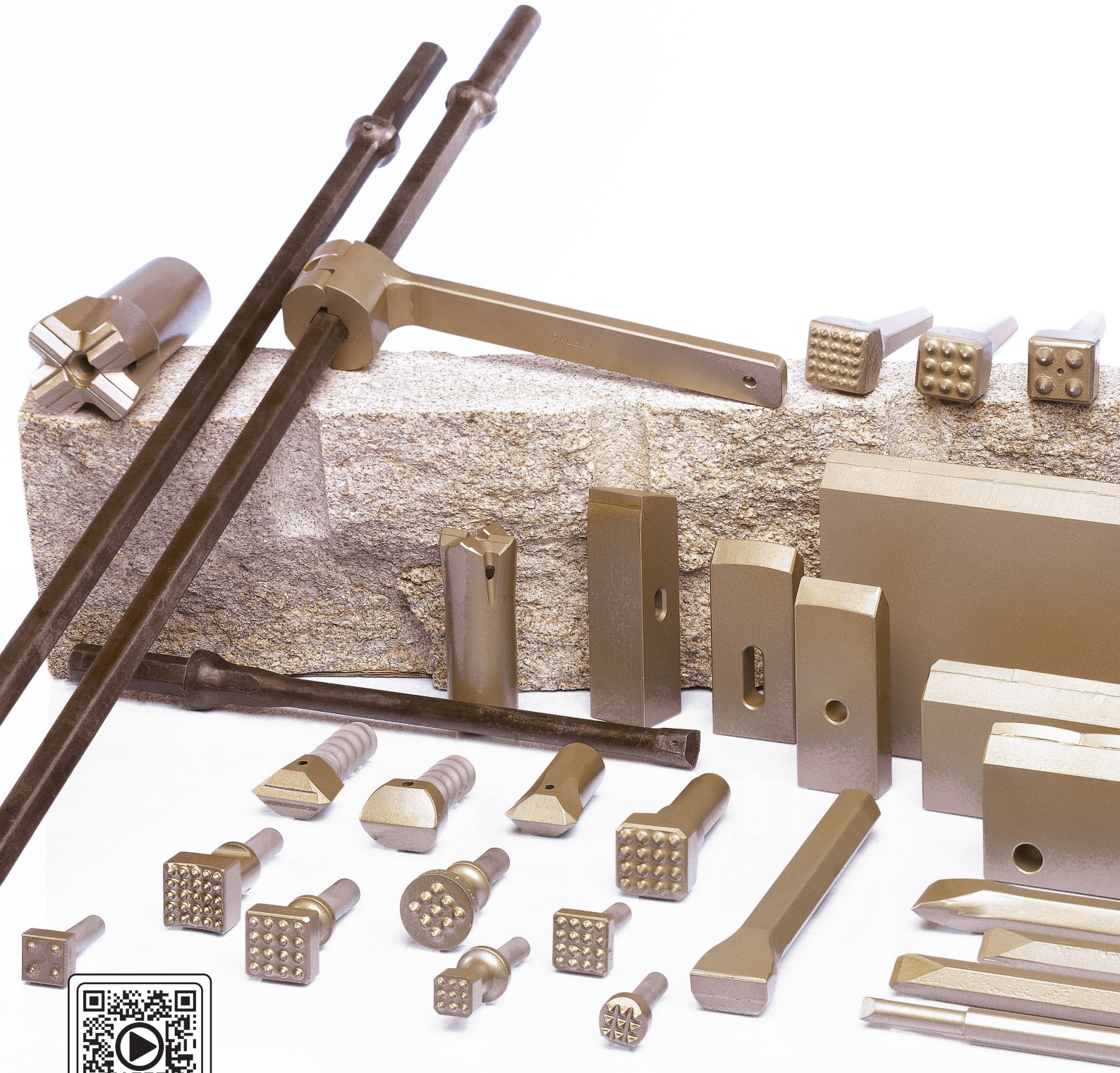

Rock Tools
Catalogue



VIDEO

SINCE 1916

PAG. 5

PAG. 31

PAG. 51

PAG. 59



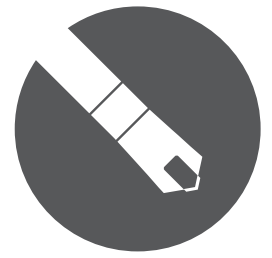

DRILLING
EQUIPMENT



FINISHING
TOOLS



SPLITTING
TOOLS



INSERTS

Tools Overview

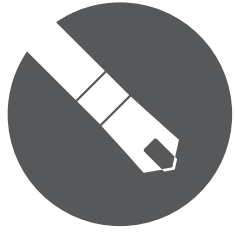

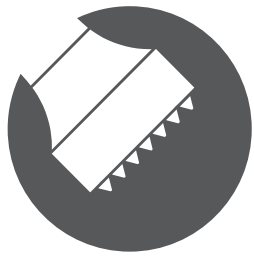

DRILLING
EQUIPMENT

Integral Drill Rods	Tapered Rods	Splitters	
			
Pag. 6	Pag. 11	Pag. 11	

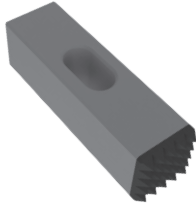

FINISHING
TOOLS

Bushes	Hammers	Chisels	
			
Pag. 32	Pag. 42	Pag. 44	





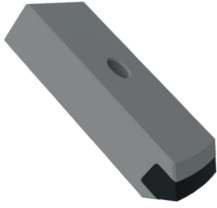
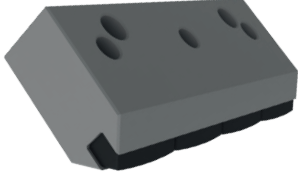
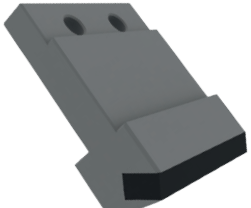

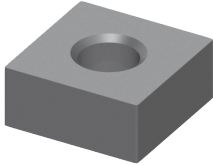

SPLITTING
TOOLS

Top Splitting	Bottom Splitting	Crush Tool Barmac	
			
Pag. 52	Pag. 55	Pag. 58	



INSERTS

Inserts for Chainsaw	Buttons	Plates	
			
Pag. 61	Pag. 62	Pag. 63	

Mini Drills	Shank, Extension and Coupling Rod	Bits
		
Pag. 18	Pag. 22	Pag. 26

Pitchers	Stone Stamp	Stone Hammers
		
Pag. 46	Pag. 47	Pag. 49

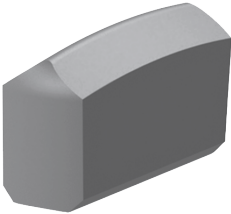
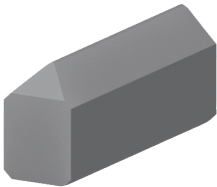
Inserts for Integral Drill	Inserts for Splitting
	
Pag. 64	Pag. 65

E-COMMERCE

ANYTIME, ANYWHERE

Online ordering available 24-hour per day and shipments around the globe.



WWW.CLIENTS.PALBIT.PT



DRILLING EQUIPMENT

Integral Drill Rods	Tapered Rods	Splitters	Mini Drills	Shank, Extension and Coupling Rod	Bits
					
Pag. 6	Pag. 11	Pag. 14	Pag. 18	Pag. 20	Pag. 26

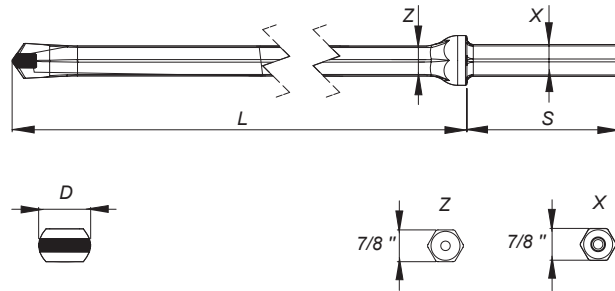

Example Exemplo Ejemplo	R	1 - Steel [Z and X measure] Aço [cota Z e X] Acero [medida Z y X]
	P	25mm (1")
	R	22mm (7/8")
	S	19mm (3/4")
	A	2 - Shank [S measure] Encabadouro [cota S] Culata [medida S]
	A	108mm (4 1/4")
	B	82,5mm (3 1/4")
	D	159mm (6 1/4")
	24	3 - Length [L measure] Comprimento [cota L] Longitud [medida L]
	xx	Length [dm] Comprimento [dm] Longitud [dm]
	32	4 - Diameter [D measure] Diâmetro [cota D] Diámetro [medida D]
	xx	Head Diameter [mm] Diâmetro da Cabeça [mm] Diámetro de la Cabeza [mm]

Integral Drill Rod H22 (7/8") | Barrena H22 (7/8")

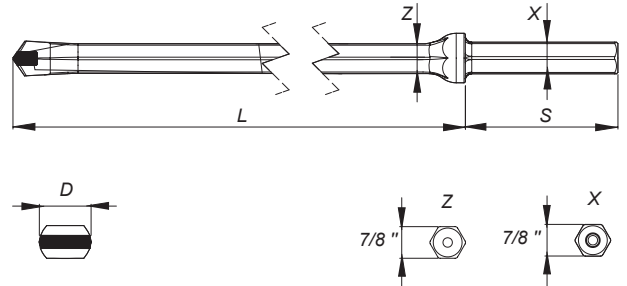

Order code Código de artigo Código producto	Reference Referência Referencia	Code Type Rúbrica artigo Tipo de código	Serie	Dimensions Dimensões Dimensiones			± Kg	Stock
				S (mm)	L (mm)	D (mm)		
131012613	R-A-0834	3101	11	108	800	34	3,10	☺
131013313	R-A-1633	3101	11	108	1600	33	5,40	☺
131014113	R-A-2432	3101	11	108	2400	32	7,80	☺
131014613	R-A-3231	3101	11	108	3200	31	10,30	☺
131014813	R-A-4030	3101	11	108	4000	30	12,70	☺
131015113	R-A-4829	3101	11	108	4800	29	15,70	☺
131015313	R-A-5628	3101	11	108	5600	28	18,20	☺
131015513	R-A-6427	3101	11	108	6400	27	20,70	☺
131043813	R-A-7226	3101	11	108	7200	26	23,20	☺
131012713	R-A-0840	3101	12	108	800	40	3,10	☺
131013413	R-A-1639	3101	12	108	1600	39	5,40	☺
131014313	R-A-2438	3101	12	108	2400	38	7,80	☺
131014713	R-A-3237	3101	12	108	3200	37	10,30	☺
131015013	R-A-4036	3101	12	108	4000	36	12,70	☺
131015213	R-A-4835	3101	12	108	4800	35	15,70	☺
131015413	R-A-5634	3101	12	108	5600	34	18,20	☺
131015613	R-A-6433	3101	12	108	6400	33	20,70	☺
131015813	R-A-7232	3101	12	108	7200	32	23,20	○
131016013	R-A-8031	3101	12	108	8000	31	25,70	○
131029513	R-A-8830	3101	12	108	8800	30	28,30	○
131011213	R-A-0434	3101	13	108	400	34	1,80	☺
131025513	R-A-0833	3101	13	108	800	33	3,10	○
131021813	R-A-1232	3101	13	108	1200	32	4,30	○
131047213	R-A-1631	3101	13	108	1600	31	5,40	○
131025613	R-A-2030	3101	13	108	2000	30	6,60	○
131012113	R-A-0635	3101	16	108	600	35	2,40	○
131013013	R-A-1234	3101	16	108	1200	34	4,30	○
131013713	R-A-1833	3101	16	108	1800	33	6,00	○
131014113	R-A-2432	3101	16	108	2400	32	7,80	☺
131027213	R-A-0641	3101	17	108	600	41	2,40	○
131013113	R-A-1240	3101	17	108	1200	40	4,30	○
131013813	R-A-1839	3101	17	108	1800	39	6,00	○
131014313	R-A-2438	3101	17	108	2400	38	7,80	☺

☺ Stock item | Produto de stock | Itens de stock

○ Available under request | Disponível sobre consulta | Disponible bajo consulta

Note: Other dimensions available under request | Outras dimensões disponíveis sob consulta | Otras dimensiones disponibles bajo consulta

Drilling Equipment | Equipamentos de Perfuração | Herramientas de Perforación

Integral Drill Rod H22 (7/8") | Barrena H22 (7/8")

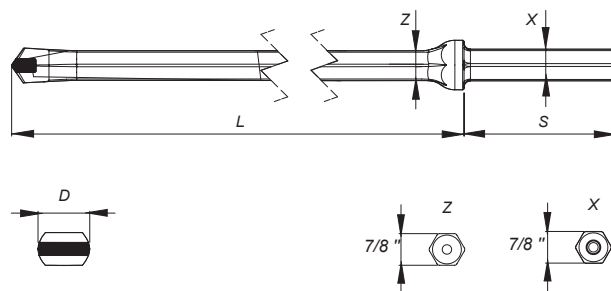

Drilling Equipment

Finishing Stone Tools

Splitting Tools

Inserts

Order code Código de artigo Código producto	Reference Referência Referencia	Code Type Rúbrica artigo Tipo de código	Serie	Dimensions Dimensões Dimensiones			± Kg	Stock
				S (mm)	L (mm)	D (mm)		
131044113	R-B-0834	3101	11	82,5	800	34	3,00	○
131044213	R-B-1633	3101	11	82,5	1600	33	5,30	○
131046713	R-B-2432	3101	11	82,5	2400	32	8,00	○
131044413	R-B-3231	3101	11	82,5	3200	31	10,20	○
131044513	R-B-4030	3101	11	82,5	4000	30	12,70	○
131044613	R-B-4829	3101	11	82,5	4800	29	15,60	○
131044713	R-B-5628	3101	11	82,5	5600	28	18,10	○
131044813	R-B-6427	3101	11	82,5	6400	27	20,60	○
131044913	R-B-7226	3101	11	82,5	7200	26	23,20	○
131045013	R-B-0840	3101	12	82,5	800	40	3,00	○
131045113	R-B-1639	3101	12	82,5	1600	39	5,30	○
131045213	R-B-2438	3101	12	82,5	2400	38	8,00	○
131045313	R-B-3237	3101	12	82,5	3200	37	10,20	○
131045413	R-B-4036	3101	12	82,5	4000	36	12,70	○
131045513	R-B-4835	3101	12	82,5	4800	35	15,60	○
131045613	R-B-5634	3101	12	82,5	5600	34	18,10	○
131045713	R-B-6433	3101	12	82,5	6400	33	20,60	○
131045813	R-B-7232	3101	12	82,5	7200	32	23,20	○
131045913	R-B-8031	3101	12	82,5	8000	31	25,70	○
131046013	R-B-0434	3101	13	82,5	400	34	1,70	○
131046113	R-B-0833	3101	13	82,5	800	33	3,00	○
131046213	R-B-1232	3101	13	82,5	1200	32	4,30	○
131018713	R-B-1631	3101	13	82,5	1600	31	5,30	○
131046313	R-B-2030	3101	13	82,5	2000	30	6,60	○
131046413	R-B-0635	3101	16	82,5	600	35	2,40	○
131046513	R-B-1234	3101	16	82,5	1200	34	4,30	○
131046613	R-B-1833	3101	16	82,5	1800	33	5,90	○
131046713	R-B-2432	3101	16	82,5	2400	32	7,80	○
131046813	R-B-0641	3101	17	82,5	600	41	2,40	○
131046913	R-B-1240	3101	17	82,5	1200	40	4,30	○
131047013	R-B-1839	3101	17	82,5	1800	39	5,90	○
131045213	R-B-2438	3101	17	82,5	2400	38	7,80	○

⊗ Stock item | Produto de stock | Itens de stock

○ Available under request | Disponível sobre consulta | Disponible bajo consulta

Note: Other dimensions available under request | Outras dimensões disponíveis sob consulta | Otras dimensiones disponibles bajo consulta

Integral Drill Rod H19 (3/4") | Barrena H19 (3/4")

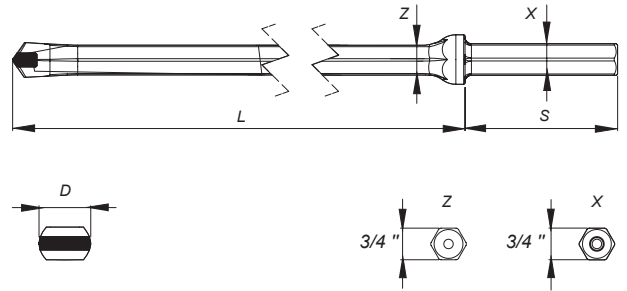

Order code Código de artigo Código producto	Reference Referência Referencia	Code Type Rúbrica artigo Tipo de código	Serie	Dimensions Dimensões Dimensiones			± Kg	Stock
				S (mm)	L (mm)	D (mm)		
131016513	S-A-0429	3101	21	108	400	29	1,40	○
131020513	S-A-0828	3101	21	108	800	28	2,40	○
131031513	S-A-1627	3101	21	108	1600	27	4,40	○
131047313	S-A-2426	3101	21	108	2400	26	6,30	○
131047413	S-A-0627	3101	24	108	600	27	1,90	○
131047513	S-A-1226	3101	24	108	1200	26	3,40	○
131029813	S-A-0434	3101	25	108	400	34	1,40	○
131044013	S-A-0435	3101	25	108	400	35	1,50	○
131033013	S-A-0834	3101	25	108	800	34	2,40	○
131023513	S-B-0429	3101	21	82,5	400	29	1,40	○
131047713	S-B-0828	3101	21	82,5	800	28	2,30	○
131047813	S-B-1627	3101	21	82,5	1600	27	4,30	○
131047913	S-B-2426	3101	21	82,5	2400	26	6,30	○
131048013	S-B-0627	3101	24	82,5	600	27	1,90	○
131016813	S-B-1226	3101	24	82,5	1200	26	3,30	○
131092813	S-B-0434	3101	25	82,5	400	34	1,40	○
131021413	S-B-0435	3101	25	82,5	400	35	1,40	○
131048113	S-B-0834	3101	25	82,5	800	34	2,30	○

⊗ Stock item | Produto de stock | Itens de stock

○ Available under request | Disponível sobre consulta | Disponible bajo consulta

Note: Other dimensions available under request | Outras dimensões disponíveis sob consulta | Otras dimensiones disponibles bajo consulta



Drilling Equipment

Finishing Stone Tools

Splitting Tools

Inserts

Integral Drill Rod H25 (1") | Barrena H25 (1")

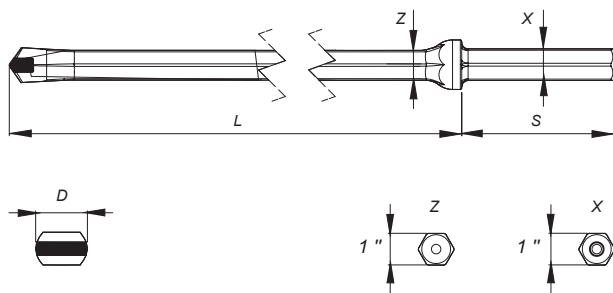

Drilling Equipment

Finishing Stone Tools

Splitting Tools

Inserts

Order code Código de artigo Código producto	Reference Referência Referencia	Code Type Rúbrica artigo Tipo de código	Serie	Dimensions Dimensões Dimensiones			± Kg	Stock
				S (mm)	L (mm)	D (mm)		
131010313	P-A-0836	3101	32	108	800	36	4,10	○
131032113	P-A-0842	3101	31	108	800	42	4,10	○
131010613	P-A-1641	3101	31	108	1600	41	7,40	○
131032213	P-A-2440	3101	31	108	2400	40	10,70	○
131034913	P-A-3239	3101	31	108	3200	39	14,00	○
131048213	P-A-4038	3101	31	108	4000	38	17,30	○
131048313	P-A-4837	3101	31	108	4800	37	20,70	○
131049013	P-B-0836	3101	34	82,5	800	36	4,00	○
131048413	P-B-0842	3101	33	82,5	800	42	4,00	○
131048513	P-B-1641	3101	33	82,5	1600	41	7,30	○
131048613	P-B-2440	3101	33	82,5	2400	40	10,60	○
131048713	P-B-3239	3101	33	82,5	3200	39	13,90	○
131048813	P-B-4038	3101	33	82,5	4000	38	17,20	○
131048913	P-B-4837	3101	33	82,5	4800	37	20,50	○
131049713	P-D-0836	3101	36	159	800	36	4,20	○
131049113	P-D-0842	3101	35	159	800	42	4,20	○
131049213	P-D-1641	3101	35	159	1600	41	7,60	○
131049313	P-D-2440	3101	35	159	2400	40	11,00	○
131049413	P-D-3239	3101	35	159	3200	39	14,30	○
131049513	P-D-4038	3101	35	159	4000	38	17,60	○
131049613	P-D-4837	3101	35	159	4800	37	20,90	○

Stock item | Produto de stock | Itens de stock

Available under request | Disponível sobre consulta | Disponible bajo consulta

Note: Other dimensions available under request | Outras dimensões disponíveis sob consulta | Otras dimensiones disponibles bajo consulta

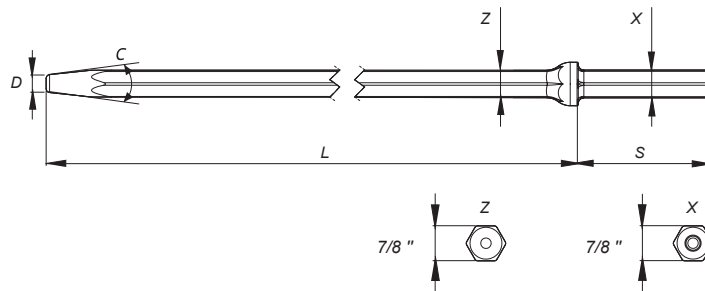

Example Exemplo Ejemplo	R	1 - Steel [Z and X measure] Aço [cota Z e X] Acero [medida Z y X]
	P	25mm (1")
	R	22mm (7/8")
	S	19mm (3/4")
	A	2 - Shank [S measure] Encabadouro [cota S] Culata [medida S]
	A	108mm (4 1/4")
	B	82,5mm (3 1/4")
	D	159mm (6 1/4")
	0800	3 - Length [L measure] Comprimento [cota L] Longitud [medida L]
	xxxx	Length [mm] Comprimento [mm] Longitud [mm]
	C12	4 -Angle Ângulo Ángulo
	C4,8	Cone with 4,8° Cone com 4,8° Cono con 4,8°
	C7	Cone with 7° Cone com 7° Cono with 7°
	C11	Cone with 11° Cone com 11° Cono con 11°
	C12	Cone with 12° Cone com 12° Cono con 12°
	D15	5 - Cone Entrance Diameter [D measure] Diâmetro da Entrada do Cone [cota D] Diámetro de Entrada del Cono [medida D]
	D15	Ø 15 mm
	D16	Ø 16 mm
	D17,5	Ø 17,5 mm
	D18,8	Ø 18,8 mm

Drilling Equipment | Equipamentos de Perfuração | Herramientas de Perforación

Tapered Rod H22 (7/8") | Barra Cônica H22 (7/8") | Barra Cono H22 (7/8")

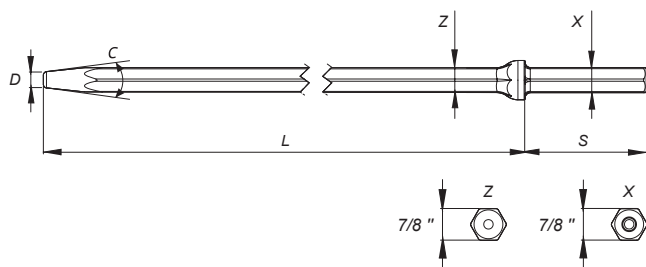

Drilling Equipment

Finishing Stone Tools

Splitting Tools

Inserts

Order code Código de artigo Código producto	Reference Referência Referencia	Code Type Rúbrica artigo Tipo de código	Dimensions Dimensões Dimensiones			± Kg	Stock			
			S (mm)	L (mm)	C (°)		4,8 °	7 °	11 °	12 °
131055300	R-A-0600 C12D15	3104	108	600	12	2,29	○	○	○	○
131055900	R-A-0915 C12D15	3104	108	915	12	3,20	○	○	○	○
131056500	R-A-1220 C12D15	3104	108	1220	12	4,20	○	○	○	○
131057100	R-A-1525 C12D15	3104	108	1525	12	5,10	○	○	○	○
131058900	R-A-1830 C12D15	3104	108	1830	12	5,30	○	○	○	○
131057700	R-A-2135 C12D15	3104	108	2135	12	7,00	○	○	○	○
131058300	R-A-2435 C12D15	3104	108	2435	12	7,90	○	○	○	○
131000600	R-A-3050 C12D15	3104	108	3050	12	9,70	○	○	○	○
131037500	R-A-0400 C12D15	3104	108	400	12	1,70	○	○	○	○
131036800	R-A-0800 C12D15	3104	108	800	12	2,90	○	○	○	⊗
131042600	R-A-1600 C12D15	3104	108	1600	12	5,30	○	○	○	⊗
131022500	R-A-2400 C12D15	3104	108	2400	12	7,80	○	○	○	⊗
131038300	R-A-3200 C12D15	3104	108	3200	12	10,20	○	○	○	⊗
131042700	R-A-4000 C12D15	3104	108	4000	12	12,60	○	○	○	○
131084600	R-A-4800 C12D15	3104	108	4800	12	15,10	○	○	○	○
131085200	R-A-5600 C12D15	3104	108	5600	12	17,50	○	○	○	○
131085300	R-A-6400 C12D15	3104	108	6400	12	20,00	○	○	○	○
131025300	R-A-7200 C12D15	3104	108	7200	12	22,40	○	○	○	○
131086300	R-A-8000 C12D15	3104	108	8000	12	24,80	○	○	○	○
131086800	R-A-8800 C12D15	3104	108	8800	12	27,30	○	○	○	○
131059500	R-B-0610 C12D15	3104	82,5	610	12	2,20	○	○	○	○
131060100	R-B-0915 C12D15	3104	82,5	915	12	3,20	○	○	○	○
131060700	R-B-1220 C12D15	3104	82,5	1220	12	4,10	○	○	○	○
131061300	R-B-1525 C12D15	3104	82,5	1525	12	5,00	○	○	○	○
131061900	R-B-1830 C12D15	3104	82,5	1830	12	6,00	○	○	○	○
131090200	R-B-2135 C12D15	3104	82,5	2135	12	6,90	○	○	○	○
131062500	R-B-2435 C12D15	3104	82,5	2435	12	7,80	○	○	○	○
131063100	R-B-3050 C12D15	3104	82,5	3050	12	9,70	○	○	○	○
131063700	R-B-0400 C12D15	3104	82,5	400	12	1,60	○	○	○	○
131090300	R-B-0800 C12D15	3104	82,5	800	12	2,80	○	○	○	○
131064300	R-B-1600 C12D15	3104	82,5	1600	12	5,30	○	○	○	○
131064900	R-B-2400 C12D15	3104	82,5	2400	12	7,70	○	○	○	○
131065500	R-B-3200 C12D15	3104	82,5	3200	12	10,20	○	○	○	○
131066100	R-B-4000 C12D15	3104	82,5	4000	12	12,60	○	○	○	○

⊗ Stock item | Produto de stock | Itens de stock ○ Available under request | Disponível sobre consulta | Disponible bajo consulta
 Note: Other dimensions available under request | Outras dimensões disponíveis sob consulta | Otras dimensiones disponibles bajo consulta

Reference Example: | Exemplo de Referência: | Ejemplo de Referencia:

Note: Default codes for this type of cone.
 Nota: Códigos por defeito para este tipo de cone.
 Nota: Códigos predeterminados para este tipo de cono.

Reference	C (°)	D (mm)
R-A-2400 C4,8D18,8	4,8	18,8
R-A-2400 C7D16	7	16
R-A-2400 C11D17,5	11	17,5
R-A-2400 C12D15	12	15

Tapered Rod H25 (1") | Barra Cônica H25 (1") | Barra Cono H25 (1")

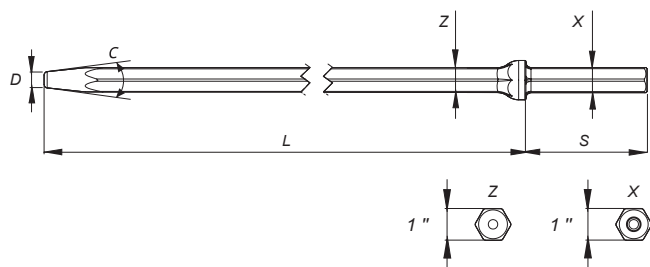

Order code Código de artigo Código producto	Reference Referência Referencia	Code Type Rúbrica artigo Tipo de código	Dimensions Dimensões Dimensiones			± Kg	Stock			
			S (mm)	L (mm)	C (°)		4,8 °	7 °	11 °	12 °
131066700	P-A-0610 C12D15	3104	108	610	12	3,10	○	○	○	○
131067300	P-A-0915 C12D15	3104	108	915	12	4,40	○	○	○	○
131067900	P-A-1220 C12D15	3104	108	1220	12	5,60	○	○	○	○
131068500	P-A-1525 C12D15	3104	108	1525	12	6,90	○	○	○	○
131069100	P-A-1830 C12D15	3104	108	1830	12	8,20	○	○	○	○
131069700	P-A-2135 C12D15	3104	108	2135	12	9,50	○	○	○	○
131070300	P-A-2435 C12D15	3104	108	2435	12	10,70	○	○	○	○
131070900	P-A-3050 C12D15	3104	108	3050	12	13,20	○	○	○	○
131071500	P-A-0400 C12D15	3104	108	400	12	2,20	○	○	○	○
131072100	P-A-0800 C12D15	3104	108	800	12	3,90	○	○	○	○
131072700	P-A-1600 C12D15	3104	108	1600	12	7,20	○	○	○	○
131073300	P-A-2400 C12D15	3104	108	2400	12	10,50	○	○	○	○
131073900	P-A-3200 C12D15	3104	108	3200	12	13,90	○	○	○	○
131074500	P-A-4000 C12D15	3104	108	4000	12	17,20	○	○	○	○
131075100	P-B-0610 C12D15	3104	82,5	610	12	3,00	○	○	○	○
131075700	P-B-0915 C12D15	3104	82,5	915	12	4,30	○	○	○	○
131076300	P-B-1220 C12D15	3104	82,5	1220	12	5,60	○	○	○	○
131076900	P-B-1525 C12D15	3104	82,5	1525	12	6,80	○	○	○	○
131077500	P-B-1830 C12D15	3104	82,5	1830	12	8,10	○	○	○	○
131090400	P-B-2135 C12D15	3104	82,5	2135	12	9,40	○	○	○	○
131078100	P-B-2435 C12D15	3104	82,5	2435	12	10,60	○	○	○	○
131078700	P-B-3050 C12D15	3104	82,5	3050	12	13,20	○	○	○	○
131079300	P-B-0400 C12D15	3104	82,5	400	12	2,20	○	○	○	○
131079900	P-B-0800 C12D15	3104	82,5	800	12	3,80	○	○	○	○
131080500	P-B-1600 C12D15	3104	82,5	1600	12	7,10	○	○	○	○
131081100	P-B-2400 C12D15	3104	82,5	2400	12	10,50	○	○	○	○
131081700	P-B-3200 C12D15	3104	82,5	3200	12	13,80	○	○	○	○
131082300	P-B-4000 C12D15	3104	82,5	4000	12	17,10	○	○	○	○

Stock item | Produto de stock | Itens de stock Available under request | Disponível sobre consulta | Disponible bajo consulta

Note: Other dimensions available under request | Outras dimensões disponíveis sob consulta | Otras dimensiones disponibles bajo consulta

Reference Example: | Exemplo de Referência: | Ejemplo de Referencia:

Note: Default codes for this type of cone.
Nota: Códigos por defeito para este tipo de cone. →
Nota: Códigos predeterminados para este tipo de cono.

Reference	C °	D (mm)
P-A-2400 C4,8D18,8	4,8	18,8
P-A-2400 C7D21,5	7	21,2
P-A-2400 C11D17,5	11	17,5
P-A-2400 C12D15	12	15
P-A-2400 C6D19	6	19

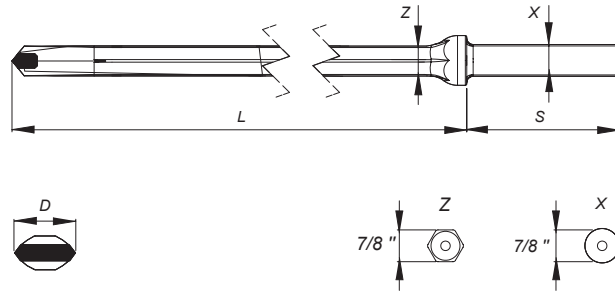

Example Exemplo Ejemplo	R	1 - Steel [Z and X measure] Aço [cota Z e X] Acero [medida Z y X]
	R	22mm (7/8")
	OA	2 - Shank [S measure] Encabadouro [cota S] Culata [medida S]
	HA	Hexagon 108 mm (41/4") Hexagonal 108mm (41/4") Hexágono 108mm (41/4")
	HB	Hexagon 82,5 mm (3 1/4") Hexagonal 82,5mm (3 1/4") Hexágono 82,5 mm (3 1/4")
	OA	Round 108 mm (41/4") Redondo de 108mm (41/4") Redondo 108 mm (41/4")
	OB	Round 82,5 mm (3 1/4") Redondo de 82,5mm (3 1/4") Redondo 82,5mm (3 1/4")
	24	3 - Length [L measure] Comprimento [cota L] Longitud [medida L]
	xx	Length [dm] Comprimento [dm] Longitud [dm]
	44	4 - Diameter [D measure] Diâmetro [cota D] Diámetro [medida D]
	xx	Head Diameter [mm] Diâmetro da Cabeça [mm] Diámetro de la Cabeza [mm]

ENGLISH

The splitter is used to create a groove in the holes pre-executed by the Integral Drill Rods, having the objective of "orient" one breakage line on the rock blocks, helping the breakdown. At the same time, enabling to increase the breakage line perfection, consequently, generating less quantity of waste and higher economic value to the block.

The splitter key serves to ensure that the splitter does not deviate from the intended cutting line.

The splitter works only with percussion, never may exist rotation. In the hexagonal shanks it's necessary to release their mechanical interlock to avoid transmit the rotation to the nozzle.

One additional benefit is the decrease of the usage of explosives.

PORTUGUÊS

A enraideira serve para criar um sulco nos furos pré-executados pelas Barrenas, tendo por objectivo "orientar" a linha de quebra dos blocos de pedra, facilitando a sua separação. Ao mesmo tempo, faz aumentar a perfeição da linha de quebra dos blocos, consequentemente gera uma menor quantidade de desperdício e maior valor económico ao bloco.

A chave de enraiar serve para garantir que a enraideira não se desvia da linha de corte pretendido.

A enraideira trabalha somente com percussão, nunca poderá existir movimento de rotação. Nos encabadouros hexagonais é necessário libertar o seu encravamento mecânico para não transmitir o movimento de rotação à boquilha.

Um benefício adicional é o de diminuir o uso de explosivos.

CASTELLANO

La barra de rayar se utiliza para crear una ranura en los agujeros pre-ejecutados por las Barrenas, que tiene el objetivo de "orientar" una línea de rotura en los bloques de roca, para ayudar a la descomposición. Al mismo tiempo permite aumentar la perfección de la línea de rotura, en consecuencia, generando menos cantidad de residuos y un mayor valor económico para el bloque.

La clave de rayar consiste en garantizar que la barra de rayar no se desvia de la línea de corte prevista.

La barra de rayar sólo funciona con percusión, nunca podrá existir el movimiento de rotación. En las culatas hexagonales es necesario liberar su enclavamiento mecánico para no transmitir la rotación a la boquilla.

Un beneficio adicional es la disminución del uso de explosivos.



Without Splitter
Sem Enraideira
Sin Barra de Rayar



With Splitter
Com Enraideira
Con Barra de Rayar

Splitter 022 (7/8") | Enraideira 022 (7/8") | Barra de Rayar 022 (7/8")

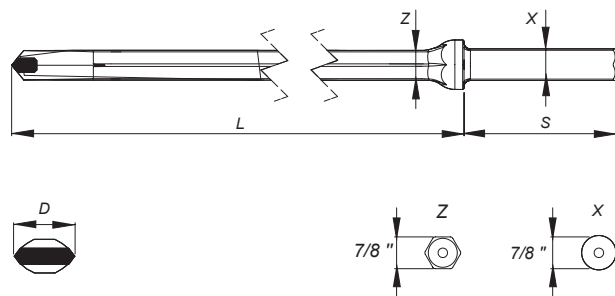

Order code Código de artigo Código producto	Reference Referência Referencia	Code Type Rúbrica artigo Tipo de código	Serie	Dimensions Dimensões Dimensiones			± Kg	Stock
				S (mm)	L (mm)	D (mm)		
131001934	R-0A-0842	3102	E02	108	800	42	3,10	⊗
131002834	R-0A-1641	3102	E02	108	1600	41	5,60	⊗
131003434	R-0A-2440	3102	E02	108	2400	40	8,10	⊗
131004034	R-0A-3239	3102	E02	108	3200	39	10,60	⊗
131004334	R-0A-4038	3102	E02	108	4000	38	13,10	⊗
131004734	R-0A-4837	3102	E02	108	4800	37	15,70	⊗
131004934	R-0A-5636	3102	E02	108	5600	36	18,20	⊗
131005334	R-0A-6435	3102	E02	108	6400	35	20,70	⊗
131002034	R-0A-0846	3102	E01	108	800	46	3,10	⊗
131003034	R-0A-1645	3102	E01	108	1600	45	5,60	⊗
131003534	R-0A-2444	3102	E01	108	2400	44	8,10	⊗
131004134	R-0A-3243	3102	E01	108	3200	43	10,60	⊗
131004534	R-0A-4042	3102	E01	108	4000	42	13,10	⊗
131004834	R-0A-4841	3102	E01	108	4800	41	15,70	⊗
131005034	R-0A-5640	3102	E01	108	5600	40	18,20	⊗
131005534	R-0A-6439	3102	E01	108	6400	39	20,70	⊗
131005834	R-0A-7238	3102	E01	108	7200	38	23,20	⊗
131006034	R-0A-8037	3102	E01	108	8000	37	25,70	○
131088734	R-0A-8836	3102	E01	108	8800	36	28,30	○
131053734	R-0B-0842	3102	E04	82,5	800	42	3,00	○
131053834	R-0B-1641	3102	E04	82,5	1600	41	5,50	○
131053934	R-0B-2440	3102	E04	82,5	2400	40	8,00	○
131054034	R-0B-3239	3102	E04	82,5	3200	39	10,60	○
131054134	R-0B-4038	3102	E04	82,5	4000	38	13,10	○
131054234	R-0B-4837	3102	E04	82,5	4800	37	15,60	○
131054334	R-0B-5636	3102	E04	82,5	5600	36	18,10	○
131054434	R-0B-6435	3102	E04	82,5	6400	35	20,60	○
131052734	R-0B-0846	3102	E03	82,5	800	46	3,00	○
131052834	R-0B-1645	3102	E03	82,5	1600	45	5,50	○
131052934	R-0B-2444	3102	E03	82,5	2400	44	8,00	○
131053034	R-0B-3243	3102	E03	82,5	3200	43	10,60	○
131053134	R-0B-4042	3102	E03	82,5	4000	42	13,10	○
131053234	R-0B-4841	3102	E03	82,5	4800	41	15,60	○
131053334	R-0B-5640	3102	E03	82,5	5600	40	18,10	○
131053434	R-0B-6439	3102	E03	82,5	6400	39	20,60	○
131053534	R-0B-7238	3102	E03	82,5	7200	38	23,20	○
131053634	R-0B-8037	3102	E03	82,5	8000	37	25,70	○

⊗ Stock item | Produto de stock | Itens de stock

○ Available under request | Disponível sobre consulta | Disponible bajo consulta

Note: Other dimensions available under request | Outras dimensões disponíveis sob consulta | Otras dimensiones disponibles bajo consulta

Drilling Equipment | Equipamentos de Perfuração | Herramientas de Perforación

Splitter H22 (7/8") | Enraideira H22 (7/8") | Barra de Rayar H22 (7/8")

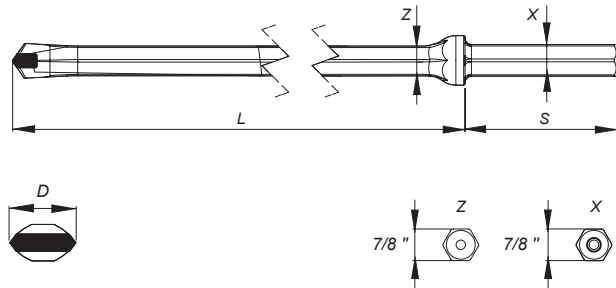

Drilling Equipment

Finishing Stone Tools

Splitting Tools

Inserts

Order code Código de artigo Código producto	Reference Referência Referencia	Code Type Rúbrica artigo Tipo de código	Serie	Dimensions Dimensões Dimensiones			± Kg	Stock
				S (mm)	L (mm)	D (mm)		
131049834	R-HA-0846	3102	E61	108	800	46	3,10	○
131049934	R-HA-1645	3102	E61	108	1600	45	5,60	○
131050034	R-HA-2444	3102	E61	108	2400	44	8,10	○
131050134	R-HA-3243	3102	E61	108	3200	43	10,60	○
131050234	R-HA-4042	3102	E61	108	4000	42	13,10	○
131050334	R-HA-4841	3102	E61	108	4800	41	15,70	○
131090134	R-HA-5640	3102	E61	108	5600	40	18,20	○
131050534	R-HA-6439	3102	E61	108	6400	39	20,70	○
131050634	R-HA-7238	3102	E61	108	7200	38	23,20	○
131050734	R-HA-8037	3102	E61	108	8000	37	25,70	○
131034234	R-HA-0842	3102	E62	108	800	42	3,10	○
131006734	R-HA-1641	3102	E62	108	1600	41	5,60	○
131007534	R-HA-2440	3102	E62	108	2400	40	8,10	○
131035134	R-HA-3239	3102	E62	108	3200	39	10,60	○
131050834	R-HA-4038	3102	E62	108	4000	38	13,10	○
131050934	R-HA-4837	3102	E62	108	4800	37	15,70	○
131009034	R-HA-5636	3102	E62	108	5600	36	18,20	○
131009334	R-HA-6435	3102	E62	108	6400	35	20,70	○
131051034	R-HB-0846	3102	E63	82,5	800	46	3,00	○
131051134	R-HB-1645	3102	E63	82,5	1600	45	5,50	○
131051234	R-HB-2444	3102	E63	82,5	2400	44	8,00	○
131051334	R-HB-3243	3102	E63	82,5	3200	43	10,60	○
131051434	R-HB-4042	3102	E63	82,5	4000	42	13,10	○
131051534	R-HB-4841	3102	E63	82,5	4800	41	15,60	○
131051634	R-HB-5640	3102	E63	82,5	5600	40	18,10	○
131051734	R-HB-6439	3102	E63	82,5	6400	39	20,60	○
131051834	R-HB-7238	3102	E63	82,5	7200	38	23,20	○
131051934	R-HB-8037	3102	E63	82,5	8000	37	25,70	○
131052034	R-HB-0842	3102	E64	82,5	800	42	3,00	○
131052134	R-HB-1641	3102	E64	82,5	1600	41	5,50	○
131026334	R-HB-2440	3102	E64	82,5	2400	40	8,00	○
131052234	R-HB-3239	3102	E64	82,5	3200	39	10,60	○
131052334	R-HB-4038	3102	E64	82,5	4000	38	13,10	○
131052434	R-HB-4837	3102	E64	82,5	4800	37	15,60	○
131052534	R-HB-5636	3102	E64	82,5	5600	36	18,10	○
131052634	R-HB-6435	3102	E64	82,5	6400	35	20,60	○

Stock item | Produto de stock | Itens de stock

Available under request | Disponível sobre consulta | Disponible bajo consulta

Note: Other dimensions available under request | Outras dimensões disponíveis sob consulta | Otras dimensiones disponibles bajo consulta

Drilling Equipment | Equipamentos de Perfuração | Herramientas de Perforación

Splitter Key | Chave de Enraiar | Clave de Rayar

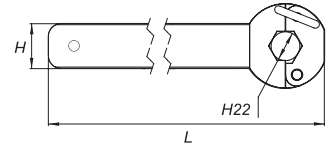

Order code Código de artigo Código producto	Reference Referência Referencia	Code Type Rúbrica artigo Tipo de código	Dimensions Dimensões Dimensiones		± Kg	Stock
			L (mm)	H (mm)		
190011200	Chave Enraideira	3102	308	35	1,84	○

☑ Stock item | Produto de stock | Itens de stock

○ Available under request | Disponível sobre consulta | Disponible bajo consulta

Note: Other dimensions available under request | Outras dimensões disponíveis sob consulta | Otras dimensiones disponibles bajo consulta



Drilling Equipment

Finishing Stone Tools

Splitting Tools

Inserts

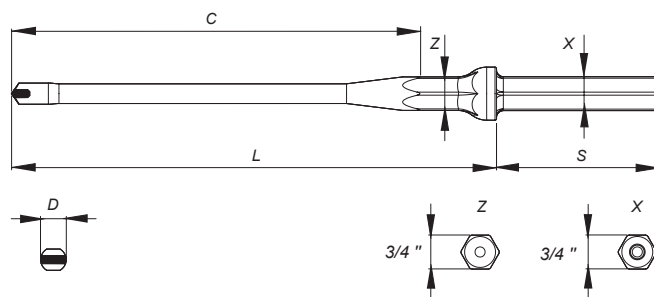

S	1 - Steel [Z and X measure] Aço [cota Z e X] Acero [medida Z y X]	
	R	22 mm (7/8")
S	19 mm (3/4")	
B	2 - Shank [S measure] Encabadouro [cota S] Culata [medida S]	
	A	108 mm (4 1/4")
B	82,5 mm (3 1/4")	
0250	3 - Length [L measure] Comprimento [cota L] Longitud [medida L]	
	xxxx	Length [mm] Comprimento [mm] Longitud [mm]
23	4 - Diameter [D measure] Diâmetro [cota D] Diámetro [medida D]	
	xx	Head Diameter [mm] Diâmetro da Cabeça [mm] Diámetro de la Cabeza [mm]
T	5 - Round Body Torneada Barrenas de Cuerpo Cilíndrico	
	T	Round body ("turning") Torneada Cuerpo cilíndrico ("torneado")

Mini Drill H22 (7/8") | Barrena Torneada H22 (7/8")

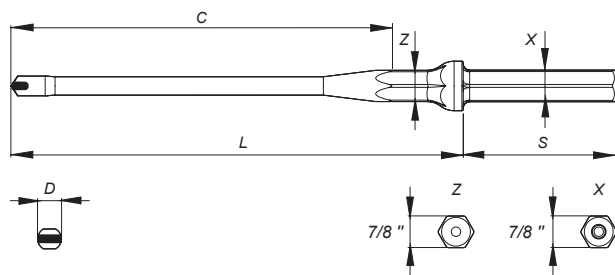
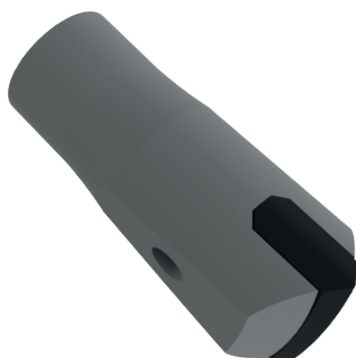

Order code Código de artigo Código producto	Reference Referência Referencia	Code Type Rúbrica artigo Tipo de código	Dimensions Dimensões Dimensiones				± Kg	Stock
			S (mm)	L (mm)	D (mm)	C (mm)		
131054513	R-A-020023T	3103	108	200	23	150	0,90	○
131017113	R-A-025023T	3103	108	250	23	200	1,00	○
131017213	R-A-032023T	3103	108	320	23	270	1,10	⊗
131054613	R-A-033023T	3103	108	330	23	280	1,10	○
131054713	R-A-035023T	3103	108	350	23	290	1,10	○
131017313	R-A-040023T	3103	108	400	23	300	1,20	⊗
131017613	R-B-025023T	3103	82,5	250	23	200	1,00	○
131017713	R-B-032023T	3103	82,5	320	23	270	1,10	○
131054813	R-B-040023T	3103	82,5	400	23	300	1,20	○

⊗ Stock item | Produto de stock | Itens de stock

○ Available under request | Disponível sobre consulta | Disponible bajo consulta

Note: Other dimensions available under request | Outras dimensões disponíveis sob consulta | Otras dimensiones disponibles bajo consulta

Mini Drill H19 (3/4") | Barrena Torneada H19 (3/4")

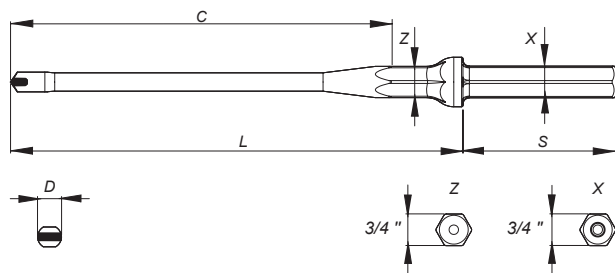
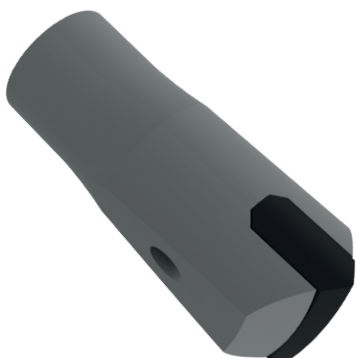

Order code Código de artigo Código producto	Reference Referência Referencia	Code Type Rúbrica artigo Tipo de código	Dimensions Dimensões Dimensiones				± Kg	Stock
			S (mm)	L (mm)	D (mm)	C (mm)		
131027513	S-A-020023T	3103	108	200	23	150	0,80	○
131017813	S-A-025023T	3103	108	250	23	200	0,80	⊗
131017913	S-A-032023T	3103	108	320	23	270	1,00	○
131021213	S-A-040023T	3103	108	400	23	300	1,10	○
131093313	S-A-050023T	3103	108	500	23	400	1,30	○
131018013	S-B-025023T	3103	82,5	250	23	200	0,80	⊗
131020313	S-B-050023T	3103	82,5	500	23	400	1,30	○

⊗ Stock item | Produto de stock | Itens de stock

○ Available under request | Disponível sobre consulta | Disponible bajo consulta

Note: Other dimensions available under request | Outras dimensões disponíveis sob consulta | Otras dimensiones disponibles bajo consulta

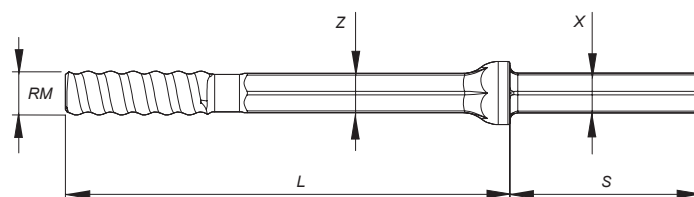

Example | Exemplo | Ejemplo

R	1 - Steel [Z and X measure] Aço [cota Z e X] Acero [medida Z y X]
P	25 mm (1")
R	22 mm (7/8")
A	2 - Shank [S measure] Encabadouro [cota S] Culata [medida S]
A	108 mm (4 1/4")
0800	3 - Length [L measure] Comprimento [cota L] Longitud [medida L]
xxxx	Length [mm] Comprimento [mm] Longitud [mm]
RM	4 - Connection Type Tipo de Conexão Tipo de la Conexión
RM	Male Thread Rope Rosca Cordão Macho Cordón Rosca Macho
25E	5 - Connection Diameter Diâmetro de Conexão Diámetro de la Conexión
xx	Thread diameter Diâmetro de rosca Diámetro de la rosca
22	Ø 22 mm
25	Ø 25 mm
28	Ø 28 mm
32	Ø 32 mm

Shank Rod H22 (7/8") & H25 (1") | Barra Roscada H22 (7/8") & H25 (1")

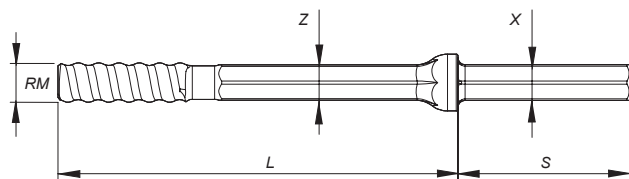
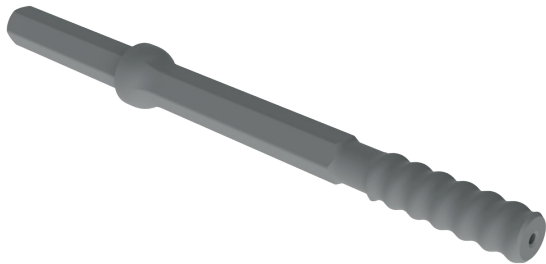

Order code Código de artigo Código producto	Reference Referência Referencia	Code Type Rúbrica artigo Tipo de código	Dimensions Dimensões Dimensiones				± Kg	Stock
			X & Y (mm)	S (mm)	L (mm)	RM (mm)		
134000600	R-A-0265 RM25E	3105	22	108	265	25	1.40	○
134001700	R-A-0610 RM25E	3105	22	108	610	25	2.50	○
134001800	R-A-0760 RM25E	3105	22	108	760	25	3.00	○
134000300	R-A-0800 RM25E	3105	22	108	800	25	3.10	⊗
134001900	R-A-1000 RM25E	3105	22	108	1000	25	3.70	○
134000400	R-A-1600 RM25E	3105	22	108	1600	25	5.60	○
134002000	R-A-3200 RM25E	3105	22	108	3200	25	10.60	○
134002100	R-A-4000 RM25E	3105	22	108	4000	25	13.20	○
134000700	P-A-0265 RM25E	3105	25	108	265	25	1.70	○
131033800	P-A-0800 RM25E	3105	25	108	800	25	3.90	○
134001500	P-A-1000 RM25E	3105	25	108	1000	25	4.70	○
134001600	P-A-1600 RM25E	3105	25	108	1600	25	7.20	○

⊗ Stock item | Produto de stock | Itens de stock

○ Available under request | Disponível sobre consulta | Disponible bajo consulta

Note: Other dimensions available under request | Outras dimensões disponíveis sob consulta | Otras dimensiones disponibles bajo consulta

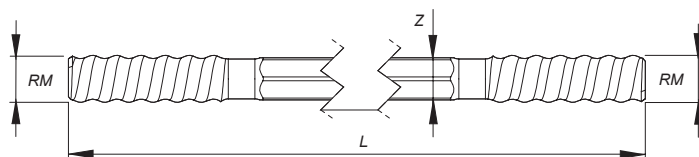

Example | Exemplo | Ejemplo

H22	1 - Steel [Z and X measure] Aço [cota Z e X] Acero [medida Z y X]
H25	25 mm (1")
H22	22 mm (7/8")
0800	2 - Length [L measure] Comprimento [cota L] Longitud [medida L]
xxxx	Length [mm] Comprimento [mm] Longitud [mm]
RM	3 - Connection Type Tipo de Conexão Tipo de la Conexión
RM	Male Thread Rope Rosca Cordão Macho Cordón Rosca Macho
25E	4 - Connection Diameter Diâmetro de Conexão Diámetro de la Conexión
xx	Thread diameter Diâmetro de rosca Diámetro de la rosca
22	Ø 22 mm
25	Ø 25 mm
28	Ø 28 mm
32	Ø 32 mm

Extension Rod H22 (7/8") & H25 (1") | Barra Extensível H22 (7/8") & H25 (1") | Barra Extensión H22 (7/8") & H25 (1")

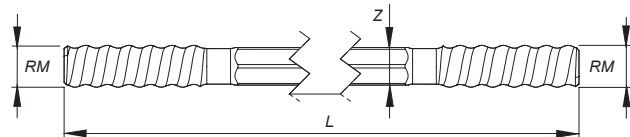

Order code Código de artigo Código producto	Reference Referência Referencia	Code Type Rúbrica artigo Tipo de código	Dimensions Dimensões Dimensiones			± Kg	Stock
			Z (mm)	L (mm)	RM (mm)		
131090500	H22-0610 RM25E	3106	22	610	25	2,10	○
131090600	H22-0800 RM25E	3106	22	800	25	2,80	○
131090700	H22-0915 RM25E	3106	22	915	25	3,10	○
131090800	H22-1200 RM25E	3106	22	1200	25	4,00	○
131090900	H22-1600 RM25E	3106	22	1600	25	5,30	○
131034400	H25-0915 RM25E	3106	25	915	25	3,80	○
131034500	H25-1220 RM25E	3106	25	1220	25	5,10	○
131091100	H25-1525 RM25E	3106	25	1525	25	6,60	○
131091200	H25-1830 RM25E	3106	25	1830	25	7,90	○
131091300	H25-2435 RM25E	3106	25	2435	25	10,40	○

⊗ Stock item | Produto de stock | Itens de stock

○ Available under request | Disponível sobre consulta | Disponible bajo consulta

Note: Other dimensions available under request | Outras dimensões disponíveis sob consulta | Otras dimensiones disponibles bajo consulta

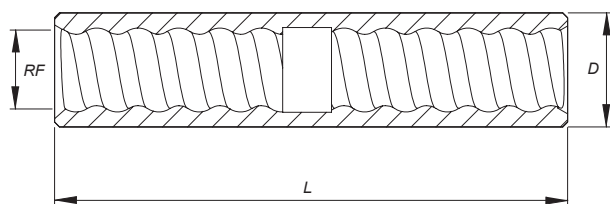

Example | Exemplo | Ejemplo

RF	1 - Connection Type Tipo de Conexão Tipo de la Conexión
RF	Female Thread Rope Rosca Cordão Fêmea Cordón Rosca Hembra
25E	2 - Connection Diameter Diâmetro de Conexão Diámetro de la Conexión
xx	Thread diameter Diâmetro de rosca Diámetro de la rosca
22	Ø 22 mm
25	Ø 25 mm
28	Ø 28 mm
32	Ø 32 mm
38	Ø 38 mm
L160	3 - Length [L measure] Comprimento [cota L] Longitud [medida L]
Lxxx	Length [mm] Comprimento [mm] Longitud [mm]
D35	4 - Diameter [D measure] Diâmetro [cota D] Diámetro [medida D]
Dxx	Diameter of the Coupling [mm] Diâmetro da União [mm] Diámetro de la Unión [mm]

Coupling | União | Unión

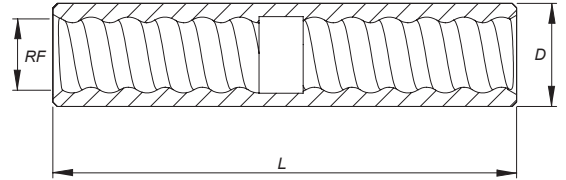
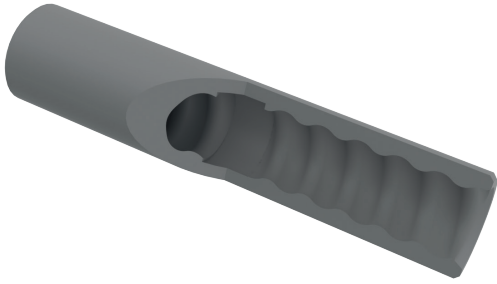

Order code Código de artigo Código producto	Reference Referência Referencia	Code Type Rúbrica artigo Tipo de código	Dimensions Dimensões Dimensiones			± Kg	Stock
			D (mm)	L (mm)	RF (mm)		
134000500	RF22E-L140-D31	3107	31	140	22	0,60	○
134001100	RF25E-L160-D35	3107	35	160	25	0,65	⊗
134002200	RF28E-L150-D40	3107	40	150	28	0,90	○
134002300	RF32E-L150-D44	3107	44	150	32	1,20	○
134001000	RF38E-L170-D55	3107	55	170	38	1,90	○

⊗ Stock item | Produto de stock | Itens de stock

○ Available under request | Disponível sobre consulta | Disponible bajo consulta

Note: Other dimensions available under request | Outras dimensões disponíveis sob consulta | Otras dimensiones disponibles bajo consulta



Drilling Equipment

Finishing Stone Tools

Splitting Tools

Inserts

Codification for Bits | Codificação de Bits | Codificación de Bocas

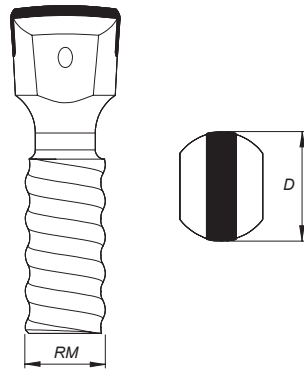

Example | Exemplo | Ejemplo

SB	1 - Bit Type Tipo de Bit Tipo de la Boca
SB	Single Blade Simples Bisel Un Bisel
DB	Double Blade in "+" Duplo Bisel em "+" Dos Biseles en "+"
XB	Double Blade in "X" Duplo Bisel em "X" Dos Biseles en "X"
45	2 - Diameter [D measure] Diâmetro [cota D] Diámetro [medida D]
xx	Diameter of the Head [mm] Diâmetro da Cabeça [mm] Diámetro de la Cabeza [mm]
RM	3 - Connection Type Tipo de Conexão Tipo de la Conexión
C4,8	4,8° Cone Cónico 4,8° 4,8 ° Cono
C7	7° Cone Cónico 7° 7 ° Cono
C12	12° Cone Cónico 12° 12 ° Cono
RM	Male Thread Rope Rosca Cordão Macho Cordón Rosca Macho
RF	Female Thread Rope Rosca Cordão Fêmea Cordón Rosca Hembra
25E	4 - Connection Diameter Diâmetro de Conexão Diámetro de la Conexión
xx	Thread diameter Diâmetro de rosca Diámetro de la rosca
	If conical, then is omitted Omitido se Cónico Si cónico, entonces se omite

Thread Bit SB | Bit de Rosca SB | Boca de Rosca SB

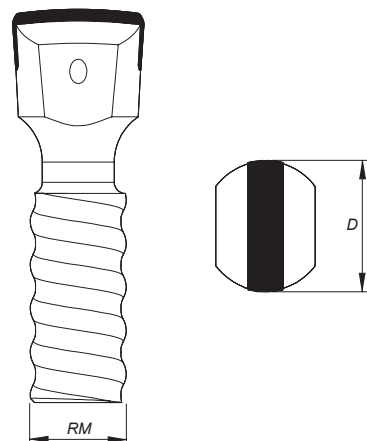

Order code Código de artigo Código producto	Reference Referência Referencia	Code Type Rúbrica artigo Tipo de código	Dimensions Dimensões Dimensiones		± Kg	Stock
			D (mm)	RM (mm)		
132015213	SB36-RM22E	3108	36	22	0,50	○
132015313	SB38-RM22E	3108	38	22	0,50	○
132015413	SB42-RM22E	3108	42	22	0,60	○
132025113	SB41-RM25E	3108	41	25	0,60	○
132000813	SB45-RM25E	3108	45	25	0,60	⊗

⊗ Stock item | Produto de stock | Itens de stock ○ Available under request | Disponível sobre consulta | Disponible bajo consulta

Note: Other dimensions available under request | Outras dimensões disponíveis sob consulta | Otras dimensiones disponibles bajo consulta

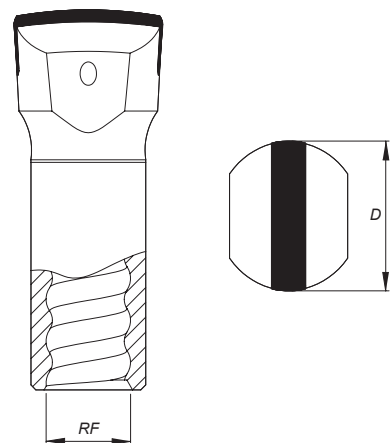

Order code Código de artigo Código producto	Reference Referência Referencia	Code Type Rúbrica artigo Tipo de código	Dimensions Dimensões Dimensiones		± Kg	Stock
			D (mm)	RF (mm)		
132000713	SB45-RF25E	3108	45	25	0,65	○

⊗ Stock item | Produto de stock | Itens de stock ○ Available under request | Disponível sobre consulta | Disponible bajo consulta

Note: Other dimensions available under request | Outras dimensões disponíveis sob consulta | Otras dimensiones disponibles bajo consulta

Thread Bit DB | Bit de Rosca DB | Boca de Rosca DB

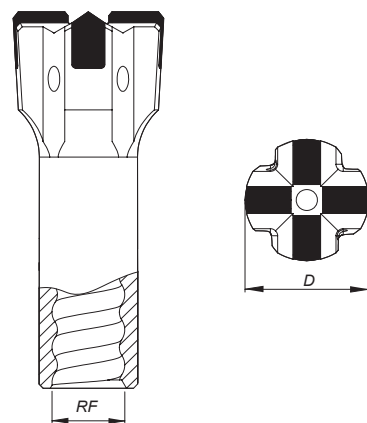

Order code Código de artigo Código producto	Reference Referência Referencia	Code Type Rúbrica artigo Tipo de código	Dimensions Dimensões Dimensiones		± Kg	Stock
			D (mm)	RF (mm)		
132025413	DB45-RF25E	3108	45	25	0,65	○
132025513	DB48-RF25E	3108	48	25	0,65	○
132024813	DB51-RF32E	3108	51	32	1,05	○
132024913	DB57-RF32E	3108	57	32	1,45	○
132025013	DB64-RF32E	3108	64	32	1,95	○
132024713	DB76-RF32E	3108	76	32	2,55	○

📦 Stock item | Produto de stock | Itens de stock

○ Available under request | Disponível sobre consulta | Disponible bajo consulta

Note: Other dimensions available under request | Outras dimensões disponíveis sob consulta | Otras dimensiones disponibles bajo consulta

Thread Bit XB | Bit de Rosca XB | Boca de Rosca XB

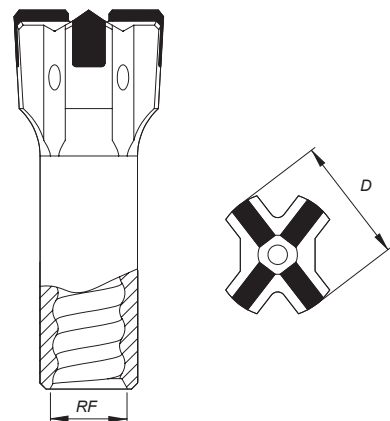

Order code Código de artigo Código producto	Reference Referência Referencia	Code Type Rúbrica artigo Tipo de código	Dimensions Dimensões Dimensiones		± Kg	Stock
			D (mm)	RF (mm)		
132025713	XB64-RF38E	3108	64	38	2,10	○

📦 Stock item | Produto de stock | Itens de stock

○ Available under request | Disponível sobre consulta | Disponible bajo consulta

Note: Other dimensions available under request | Outras dimensões disponíveis sob consulta | Otras dimensiones disponibles bajo consulta

Tapered Bit SB | Bit Cónico SB | Boca Cono SB

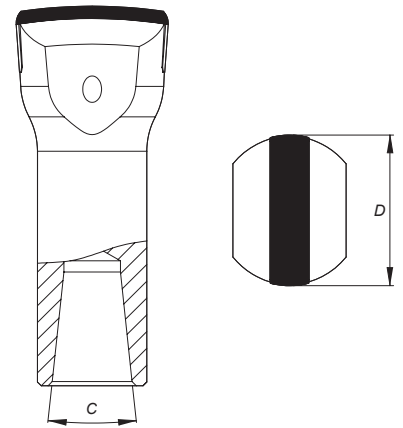

Order code Código de artigo Código producto	Reference Referência Referencia	Code Type Rúbrica artigo Tipo de código	Dimensions Dimensões Dimensiones		± Kg	Stock
			D (mm)	C (°)		
132024613	SB32-C12	3108	32	12	0,35	○
132025813	SB35-C12	3108	35	12	0,35	○
132025913	SB38-C12	3108	38	12	0,40	○
132026013	SB41-C12	3108	41	12	0,45	○
132026113	SB36-C4,8	3108	36	4,8	0,40	○
132026213	SB40-C4,8	3108	40	4,8	0,50	○
132026313	SB45-C4,8	3108	45	4,8	0,60	○

⊗ Stock item | Produto de stock | Itens de stock

○ Available under request | Disponível sobre consulta | Disponible bajo consulta

Note: Other dimensions available under request | Outras dimensões disponíveis sob consulta | Otras dimensiones disponibles bajo consulta

Tapered Bit DB | Bit Cónico DB | Boca Cono DB

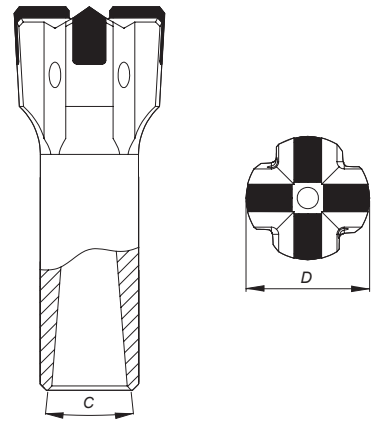

Order code Código de artigo Código producto	Reference Referência Referencia	Code Type Rúbrica artigo Tipo de código	Dimensions Dimensões Dimensiones		± Kg	Stock
			D (mm)	C (°)		
132011013	DB32-C12	3108	32	12	0,60	○
132026413	DB35-C12	3108	35	12	0,60	○
132026513	DB38-C12	3108	38	12	0,65	○
132000613	DB41-C12	3108	41	12	0,69	○
132026613	DB45-C12	3108	45	12	0,87	○
132026713	DB51-C7	3108	51	7	1,05	○
132026813	DB57-C7	3108	57	7	1,45	○
132026913	DB64-C7	3108	64	7	1,95	○

Stock item | Produto de stock | Itens de stock
 Available under request | Disponível sobre consulta | Disponible bajo consulta

Note: Other dimensions available under request | Outras dimensões disponíveis sob consulta | Otras dimensiones disponibles bajo consulta

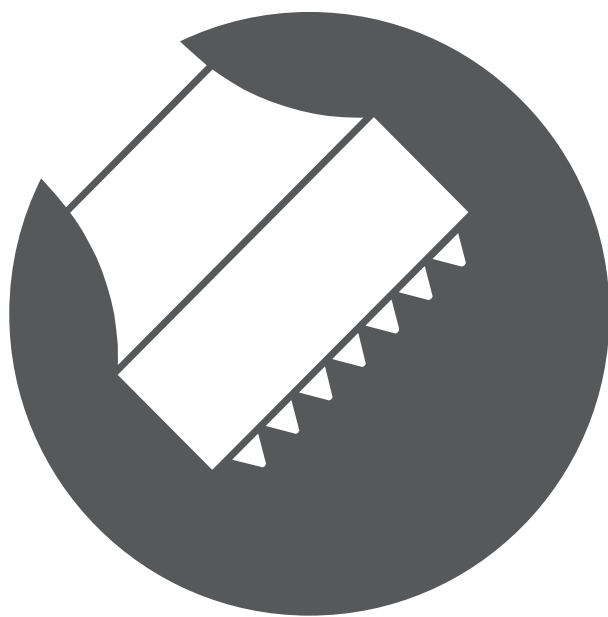

FINISHING TOOLS

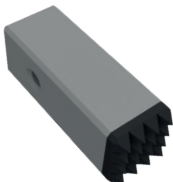
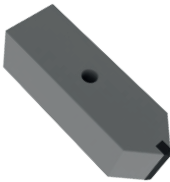
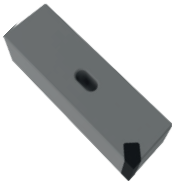
Bushes	Hammers	Chisels	Pitchers	Stone Stamp	Stone Hammers
					
Pag. 32	Pag. 42	Pag. 44	Pag. 46	Pag. 47	Pag. 49

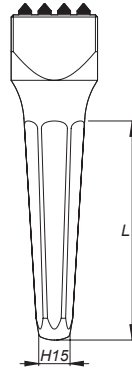

Example Exemplo Ejemplo	BU	1 - Type Tipo Tipo
	BU	Bush Bujardas Bujardas
	BUC	Bush Head Cabeça de Bujardas Cabeza de Bujarda
	BUV	"Vistas" Type Bujardas Tipo Vistas Tipo Vistas
	S40	2 - Geometry of the Head Geometria da Cabeça Geometria de la Cabeza
	Sxx	Square [mm] Quadrada [mm] Cuadrada [mm]
	Rxx	Round [mm] Redonda [mm] Redondo [mm]
	L98	3 - Length [L measure] Comprimento [L cota] Longitud [L medida]
	Lxx	Length of the Shank or Height [mm] Comprimento do encabadouro ou altura [mm] Longitud de la Culata o Altura [mm]
	H15	4 - Shank Encabadouro Culata
	Hxx	Hexagonal Hexagonal Hexagonal
	Pxx	Pellegrini (diameter) Pellegrini (diâmetro) Pellegrini (diámetro)
	Bxx	Ballerina (diameter) Bailarina (diâmetro) Bailarin (diámetro)
	Cxx	Tapered Cónico Cono
	Dxx	Cylindrical (diameter) Cilíndrico (diâmetro) Cilíndrico (diámetro)
	P04	5 - Jagged Dentado Dentado
	Pxx	Nº of Buttons Nº de Pinos Nº de Botones
	Bxx	Nº of Blades Nº de Lâminas Nº de Láminas
	Txx	Nº of teeth of the Plate Nº de dentes da Placa Nº de dientes de la Placa
		6 - Details Particularidades Detalles
	Omitted Omitido Omitido	
R	In ray (Concave) Em raio (Côncavas) En rayo (Cóncavo)	

Bush Hex. Square & Round with Buttons | Bujarda Hexagonal Quadrada & Redonda com Pinos | Bujarda Mango Cónico Fijo Cuadrada & Redonda con Botones

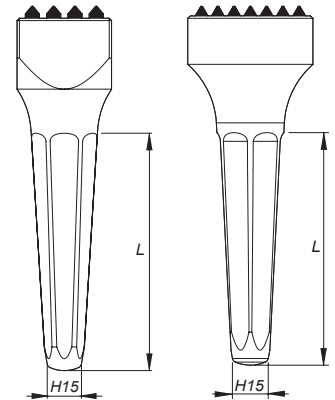
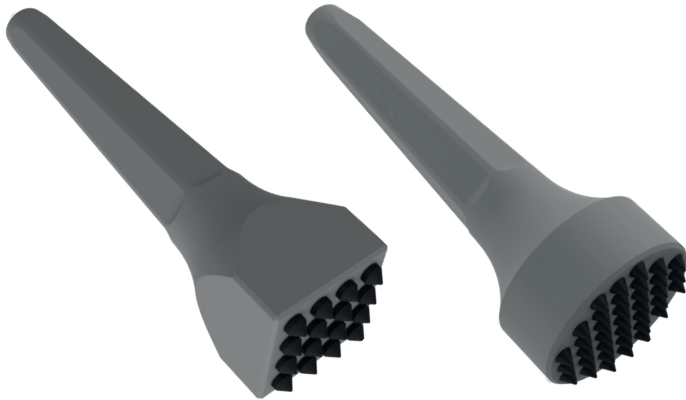

Order code Código de artigo Código producto	Reference Referência Referencia	Code Type Rúbrica artigo Tipo de código	Technical Information Informação Técnica Información Técnica				± Kg	Stock
			Sec. (mm)	L (mm)	P	Hardness		
132002713	BU-S40-L98-H15-P04	3201	□ 40	98	4	+++++	0,78	⊗
132002913	BU-S40-L98-H15-P09	3201	□ 40	98	9	+++++	0,78	⊗
132002533	BU-S40-L98-H15-P16	3201	□ 40	98	16	+++++	0,79	⊗
132002633	BU-S40-L98-H15-P25	3201	□ 40	98	25	+++++	0,80	⊗
132003533	BU-R50-L98-H15-P37	3201	∅ 50	98	37	+++++	0,96	○

⊗ Stock item | Produto de stock | Itens de stock

○ Available under request | Disponível sobre consulta | Disponible bajo consulta

Note: Other dimensions available under request | Outras dimensões disponíveis sob consulta | Otras dimensiones disponibles bajo consulta

Bush Hex. Square with Blades | Bujarda Hexagonal Quadrada com Lâminas | Bujarda Mango Cónico Fijo Cuadrada con Láminas

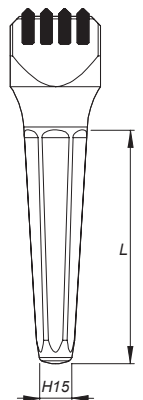

Order code Código de artigo Código producto	Reference Referência Referencia	Code Type Rúbrica artigo Tipo de código	Technical Information Informação Técnica Información Técnica				± Kg	Stock
			Sec. (mm)	L (mm)	B	Hardness		
132002834	BU-S40-L98-H15-B04	3201	□ 40	98	4	++++	0,95	○

⊗ Stock item | Produto de stock | Itens de stock

○ Available under request | Disponível sobre consulta | Disponible bajo consulta

Note: Other dimensions available under request | Outras dimensões disponíveis sob consulta | Otras dimensiones disponibles bajo consulta

Bush Shank Round with Buttons | Bujarda Encabadoiro Redondo com Pinos | Bujarda Mango Redondo con Botones

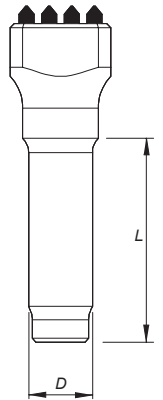

Order code Código de artigo Código producto	Reference Referência Referencia	Code Type Rúbrica artigo Tipo de código	Technical Information Informação Técnica Información Técnica					± Kg	Stock
			Sec. (mm)	L (mm)	D (mm)	P	Hardness		
132005113	BU-S40-L80-D25-P04	3201	□ 40	80	25	4	+++++	0,69	○
132008313	BU-S40-L80-D25-P09	3201	□ 40	80	25	9	+++++	0,69	○
132003433	BU-S40-L80-D25-P16	3201	□ 40	80	25	16	+++++	0,69	○
132008233	BU-S40-L80-D25-P25	3201	□ 40	80	25	25	+++++	0,71	○
132023833	BU-R50-L80-D25-P24	3201	∅ 50	80	25	24	+++++	0,75	○
132030633	BU-R50-L80-D25-P37	3201	∅ 50	80	25	37	+++++	0,80	○

Stock item | Produto de stock | Itens de stock
 Available under request | Disponível sobre consulta | Disponible bajo consulta

Note: Other dimensions available under request | Outras dimensões disponíveis sob consulta | Otras dimensiones disponibles bajo consulta

Bush Ballerina Square with Buttons | Bujarda Bailarina Quadrada com Pinos | Bujarda Bailarina Cuadrada con Botones

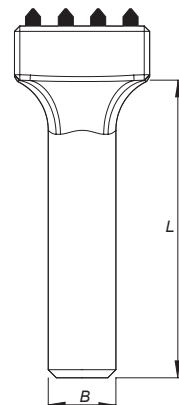

Order code Código de artigo Código producto	Reference Referência Referencia	Code Type Rúbrica artigo Tipo de código	Technical Information Informação Técnica Información Técnica					± Kg	Stock
			Sec. (mm)	L (mm)	B (mm)	P	Hardness		
132009933	BU-S20-L55-B12,5-P04	3201	□ 20	55	12,5	4	+++++	0,10	○
132003833	BU-S20-L55-B12,5-P09	3201	□ 20	55	12,5	9	+++++	0,10	○
132003733	BU-S20-L55-B12,5-P16	3201	□ 20	55	12,5	16	+++++	0,10	○
132007433	BU-S25-L55-B12,5-P04	3201	□ 25	55	12,5	4	+++++	0,10	○
132004033	BU-S25-L55-B12,5-P09	3201	□ 25	55	12,5	9	+++++	0,10	○
132005833	BU-S25-L55-B12,5-P16	3201	□ 25	55	12,5	16	+++++	0,10	○
132006233	BU-S25-L55-B12,5-P25	3201	□ 25	55	12,5	25	+++++	0,10	○
132027013	BU-S30-L55-B12,5-P04	3201	□ 30	55	12,5	4	++++	0,14	○
132006033	BU-S30-L55-B12,5-P09	3201	□ 30	55	12,5	9	+++++	0,14	○
132004133	BU-S30-L55-B12,5-P16	3201	□ 30	55	12,5	16	+++++	0,14	○
132012733	BU-S30-L55-B12,5-P25	3201	□ 30	55	12,5	25	+++++	0,14	○
132027113	BU-S35-L55-B12,5-P04	3201	□ 35	55	12,5	4	++++	0,16	○
132010833	BU-S35-L55-B12,5-P09	3201	□ 35	55	12,5	9	+++++	0,16	○
132027233	BU-S35-L55-B12,5-P16	3201	□ 35	55	12,5	16	+++++	0,16	○
132027333	BU-S35-L55-B12,5-P25	3201	□ 35	55	12,5	25	+++++	0,16	○
132027433	BU-S20-L60-B15,5-P04	3201	□ 20	60	15,5	4	+++++	0,12	○
132027533	BU-S20-L60-B15,5-P09	3201	□ 20	60	15,5	9	+++++	0,12	○
132027633	BU-S20-L60-B15,5-P16	3201	□ 20	60	15,5	16	+++++	0,12	○
132027733	BU-S25-L60-B15,5-P04	3201	□ 25	60	15,5	4	+++++	0,14	○
132027833	BU-S25-L60-B15,5-P09	3201	□ 25	60	15,5	9	+++++	0,14	○
132027933	BU-S25-L60-B15,5-P16	3201	□ 25	60	15,5	16	+++++	0,14	○
132028033	BU-S25-L60-B15,5-P25	3201	□ 25	60	15,5	25	+++++	0,14	○
132028113	BU-S30-L60-B15,5-P04	3201	□ 30	60	15,5	4	++++	0,16	○
132028233	BU-S30-L60-B15,5-P09	3201	□ 30	60	15,5	9	+++++	0,16	○
132004233	BU-S30-L60-B15,5-P16	3201	□ 30	60	15,5	16	+++++	0,16	○
132028333	BU-S30-L60-B15,5-P25	3201	□ 30	60	15,5	25	+++++	0,16	○
132028413	BU-S35-L60-B15,5-P04	3201	□ 35	60	15,5	4	++++	0,18	○
132004433	BU-S35-L60-B15,5-P09	3201	□ 35	60	15,5	9	+++++	0,18	○
132004533	BU-S35-L60-B15,5-P16	3201	□ 35	60	15,5	16	+++++	0,18	○
132028533	BU-S35-L60-B15,5-P25	3201	□ 35	60	15,5	25	+++++	0,18	○

Stock item | Produto de stock | Itens de stock

Available under request | Disponível sobre consulta | Disponible bajo consulta

Note: Other dimensions available under request | Outras dimensões disponíveis sob consulta | Otras dimensiones disponibles bajo consulta

Bush Ballerina Square with Plate | Bujarda Bailarina Quadrada com Placa | Bujarda Bailarin Cuadrada con Placa

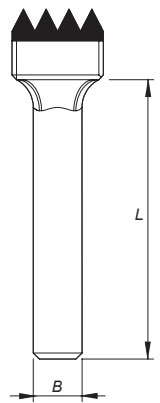

Order code Código de artigo Código producto	Reference Referência Referencia	Code Type Rúbrica artigo Tipo de código	Technical Information Informação Técnica Información Técnica					± Kg	Stock
			Sec. (mm)	L (mm)	B (mm)	T	Hardness		
132028634	BU-S20-L55-B12,5-T04	3201	□ 20	55	12,5	4	++++	0,12	○
132003934	BU-S20-L55-B12,5-T09	3201	□ 20	55	12,5	9	++++	0,12	○
132013134	BU-S20-L55-B12,5-T16	3201	□ 20	55	12,5	16	++++	0,12	○
132028734	BU-S20-L55-B12,5-T25	3201	□ 20	55	12,5	25	++++	0,12	○
132017434	BU-S25-L55-B12,5-T04	3201	□ 25	55	12,5	4	++++	0,15	○
132017534	BU-S25-L55-B12,5-T09	3201	□ 25	55	12,5	9	++++	0,15	○
132017634	BU-S25-L55-B12,5-T16	3201	□ 25	55	12,5	16	++++	0,15	○
132017734	BU-S25-L55-B12,5-T25	3201	□ 25	55	12,5	25	++++	0,15	○
132017834	BU-S30-L55-B12,5-T04	3201	□ 30	55	12,5	4	++++	0,17	○
132017934	BU-S30-L55-B12,5-T09	3201	□ 30	55	12,5	9	++++	0,17	○
132018034	BU-S30-L55-B12,5-T16	3201	□ 30	55	12,5	16	++++	0,17	○
132018134	BU-S30-L55-B12,5-T25	3201	□ 30	55	12,5	25	++++	0,17	○
132018234	BU-S20-L60-B15,5-T04	3201	□ 20	60	15,5	4	++++	0,14	○
132018334	BU-S20-L60-B15,5-T09	3201	□ 20	60	15,5	9	++++	0,14	○
132018434	BU-S20-L60-B15,5-T16	3201	□ 20	60	15,5	16	++++	0,14	○
132018534	BU-S20-L60-B15,5-T25	3201	□ 20	60	15,5	25	++++	0,14	○
132018634	BU-S25-L60-B15,5-T04	3201	□ 25	60	15,5	4	++++	0,17	○
132018734	BU-S25-L60-B15,5-T09	3201	□ 25	60	15,5	9	++++	0,17	○
132018834	BU-S25-L60-B15,5-T16	3201	□ 25	60	15,5	16	++++	0,17	○
132018934	BU-S25-L60-B15,5-T25	3201	□ 25	60	15,5	25	++++	0,17	○
132019034	BU-S30-L60-B15,5-T04	3201	□ 30	60	15,5	4	++++	0,20	○
132013234	BU-S30-L60-B15,5-T09	3201	□ 30	60	15,5	9	++++	0,20	○
132013334	BU-S30-L60-B15,5-T16	3201	□ 30	60	15,5	16	++++	0,20	○
132019134	BU-S30-L60-B15,5-T25	3201	□ 30	60	15,5	25	++++	0,20	○

⊗ Stock item | Produto de stock | Itens de stock

○ Available under request | Disponível sobre consulta | Disponible bajo consulta

Note: Other dimensions available under request | Outras dimensões disponíveis sob consulta | Otras dimensiones disponibles bajo consulta

Bush Pellegrini Square with Buttons | Bujarda Pellegrini Quadrada com Pinos | Bujarda Pellegrini Cuadrada con Botones

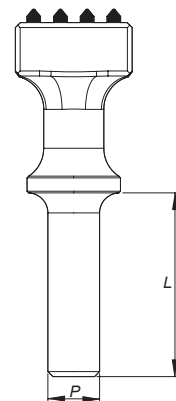

Order code Código de artigo Código producto	Reference Referência Referencia	Code Type Rúbrica artigo Tipo de código	Technical Information Informação Técnica Información Técnica					± Kg	Stock
			Sec. (mm)	L (mm)	P (mm)	P	Hardness		
132031813	BU-S30-L55-P12,5-P04	3201	□ 30	55	12,5	4	+++++	0,27	○
132011933	BU-S30-L55-P12,5-P09	3201	□ 30	55	12,5	9	+++++	0,27	○
132008633	BU-S30-L55-P12,5-P16	3201	□ 30	55	12,5	16	+++++	0,27	○
132019233	BU-S30-L55-P12,5-P25	3201	□ 30	55	12,5	25	+++++	0,27	○
132012513	BU-S30-L55-P15,5-P04	3201	□ 30	55	15,5	4	+++++	0,29	○
132019333	BU-S30-L55-P15,5-P09	3201	□ 30	55	15,5	9	+++++	0,29	○
132012333	BU-S30-L55-P15,5-P16	3201	□ 30	55	15,5	16	+++++	0,29	○
132019433	BU-S30-L55-P15,5-P25	3201	□ 30	55	15,5	25	+++++	0,29	○
132007913	BU-S35-L55-P15,5-P04	3201	□ 35	55	15,5	4	+++++	0,35	○
132007833	BU-S35-L55-P15,5-P09	3201	□ 35	55	15,5	9	+++++	0,35	○
132002133	BU-S35-L55-P15,5-P16	3201	□ 35	55	15,5	16	+++++	0,35	○
132002233	BU-S35-L55-P15,5-P25	3201	□ 35	55	15,5	25	+++++	0,35	○
132019513	BU-S40-L55-P15,5-P04	3201	□ 40	55	15,5	4	+++++	0,40	○
132003313	BU-S40-L55-P15,5-P09	3201	□ 40	55	15,5	9	+++++	0,40	○
132003233	BU-S40-L55-P15,5-P16	3201	□ 40	55	15,5	16	+++++	0,40	○
132019633	BU-S40-L55-P15,5-P25	3201	□ 40	55	15,5	25	+++++	0,40	○
132019733	BU-S35-L55-P18,0-P09	3201	□ 35	55	18,0	9	+++++	0,36	○
132019833	BU-S35-L55-P18,0-P16	3201	□ 35	55	18,0	16	+++++	0,36	○
132019933	BU-S35-L55-P18,0-P25	3201	□ 35	55	18,0	25	+++++	0,36	○
132012813	BU-S40-L55-P18,0-P09	3201	□ 40	55	18,0	9	+++++	0,40	○
132007333	BU-S40-L55-P18,0-P16	3201	□ 40	55	18,0	16	+++++	0,40	○
132020033	BU-S40-L55-P18,0-P25	3201	□ 40	55	18,0	25	+++++	0,40	○

Stock item | Produto de stock | Itens de stock

Available under request | Disponível sobre consulta | Disponible bajo consulta

Note: Other dimensions available under request | Outras dimensões disponíveis sob consulta | Otras dimensiones disponibles bajo consulta

Drilling Equipment

Finishing Stone Tools

Splitting Tools

Inserts

Bush Pellegrini Round with Buttons | Bujarda Pellegrini Redonda com Pinos | Bujarda Pellegrini Redonda con Botones

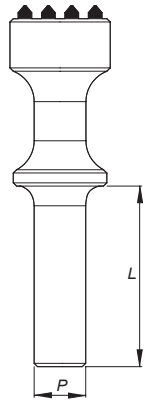

Order code Código de artigo Código producto	Reference Referência Referencia	Code Type Rúbrica artigo Tipo de código	Technical Information Informação Técnica Información Técnica					± Kg	Stock
			Sec. (mm)	L (mm)	P (mm)	P	Hardness		
132007033	BU-R30-L55-P15,5-P09	3201	Ø30	55	15,5	9	+++++	0,23	○
132008433	BU-R30-L55-P15,5-P12	3201	Ø30	55	15,5	12	+++++	0,23	○
132014533	BU-R35-L55-P15,5-P09	3201	Ø35	55	15,5	9	+++++	0,26	○
132014633	BU-R35-L55-P15,5-P12	3201	Ø35	55	15,5	12	+++++	0,26	○
132014733	BU-R35-L55-P15,5-P21	3201	Ø35	55	15,5	21	+++++	0,26	○
132014833	BU-R40-L55-P15,5-P09	3201	Ø40	55	15,5	9	+++++	0,30	○
132014933	BU-R40-L55-P15,5-P12	3201	Ø40	55	15,5	12	+++++	0,30	○
132015033	BU-R40-L55-P15,5-P21	3201	Ø40	55	15,5	21	+++++	0,30	○

Stock item | Produto de stock | Itens de stock
 Available under request | Disponível sobre consulta | Disponible bajo consulta

Note: Other dimensions available under request | Outras dimensões disponíveis sob consulta | Otras dimensiones disponibles bajo consulta

Bush Pellegrini Square with Plate | Bujarda Pellegrini Quadrada com Placa | Bujarda Pellegrini Cuadrada con Placa

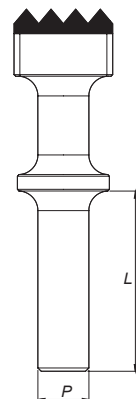

Order code Código de artigo Código producto	Reference Referência Referencia	Code Type Rúbrica artigo Tipo de código	Technical Information Informação Técnica Información Técnica					± Kg	Stock
			Sec. (mm)	L (mm)	P (mm)	T	Hardness		
132017334	BU-S30-L55-P12,5-T04	3201	□ 30	55	12,5	4	++++	0,30	○
132008834	BU-S30-L55-P12,5-T09	3201	□ 30	55	12,5	9	++++	0,30	○
132020134	BU-S30-L55-P12,5-T16	3201	□ 30	55	12,5	16	++++	0,30	○
132020234	BU-S30-L55-P12,5-T25	3201	□ 30	55	12,5	25	++++	0,30	○
132024034	BU-S30-L55-P15,5-T04	3201	□ 30	55	15,5	4	++++	0,32	○
132008934	BU-S30-L55-P15,5-T09	3201	□ 30	55	15,5	9	++++	0,32	○
132020334	BU-S30-L55-P15,5-T16	3201	□ 30	55	15,5	16	++++	0,32	○
132020434	BU-S30-L55-P15,5-T25	3201	□ 30	55	15,5	25	++++	0,32	○
132020534	BU-S35-L55-P15,5-T04	3201	□ 35	55	15,5	4	++++	0,39	○
132020634	BU-S35-L55-P15,5-T09	3201	□ 35	55	15,5	9	++++	0,39	○
132020734	BU-S35-L55-P15,5-T16	3201	□ 35	55	15,5	16	++++	0,39	○
132006134	BU-S35-L55-P15,5-T25	3201	□ 35	55	15,5	25	++++	0,39	○
132020834	BU-S40-L55-P15,5-T16	3201	□ 40	55	15,5	16	++++	0,44	○
132020934	BU-S40-L55-P15,5-T36	3201	□ 40	55	15,5	36	++++	0,44	○
132021034	BU-S40-L55-P15,5-T64	3201	□ 40	55	15,5	64	++++	0,44	○
132021134	BU-S35-L55-P18,0-T09	3201	□ 35	55	18,0	9	++++	0,34	○
132021234	BU-S35-L55-P18,0-T16	3201	□ 35	55	18,0	16	++++	0,34	○
132021334	BU-S35-L55-P18,0-T25	3201	□ 35	55	18,0	25	++++	0,34	○
132021434	BU-S40-L55-P18,0-T16	3201	□ 40	55	18,0	16	++++	0,46	○
132028834	BU-S40-L55-P18,0-T36	3201	□ 40	55	18,0	36	++++	0,46	○
132021634	BU-S40-L55-P18,0-T64	3201	□ 40	55	18,0	64	++++	0,46	○

⊗ Stock item | Produto de stock | Itens de stock

○ Available under request | Disponível sobre consulta | Disponible bajo consulta

Note: Other dimensions available under request | Outras dimensões disponíveis sob consulta | Otras dimensiones disponibles bajo consulta

Bush Head with Buttons & Plate | Cabeça de Bujarda com Pinos & Placa | Cabeza de Bujarda con Botones & Placa

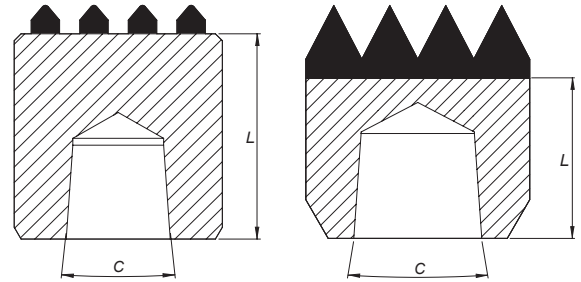
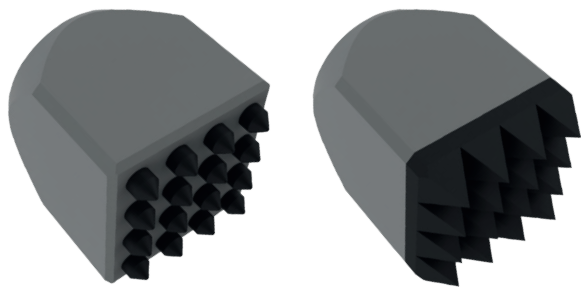

Order code Código de artigo Código producto	Reference Referência Referencia	Code Type Rúbrica artigo Tipo de código	Technical Information Informação Técnica Información Técnica					± Kg	Stock
			Sec. (mm)	L (mm)	C (°)	P / T	Hardness		
132021713	BUC-S30-L30-C08-P04	3201	□30	30	8	4	+++++	0,20	○
132011633	BUC-S30-L30-C08-P09	3201	□30	30	8	9	+++++	0,20	○
132021833	BUC-S30-L30-C08-P16	3201	□30	30	8	16	+++++	0,20	○
132021933	BUC-S30-L30-C08-P25	3201	□30	30	8	25	+++++	0,20	○
132022013	BUC-S35-L30-C08-P04	3201	□35	30	8	4	+++++	0,23	○
132022133	BUC-S35-L30-C08-P09	3201	□35	30	8	9	+++++	0,23	○
132022233	BUC-S35-L30-C08-P16	3201	□35	30	8	16	+++++	0,23	○
132022333	BUC-S35-L30-C08-P25	3201	□35	30	8	25	+++++	0,23	○
132015113	BUC-S40-L30-C08-P04	3201	□40	30	8	4	+++++	0,27	○
132022413	BUC-S40-L30-C08-P09	3201	□40	30	8	9	+++++	0,27	○
132022533	BUC-S40-L30-C08-P16	3201	□40	30	8	16	+++++	0,27	○
132022633	BUC-S40-L30-C08-P25	3201	□40	30	8	25	+++++	0,27	○
132022734	BUC-S25-L30-C08-T04	3201	□25	30	8	4	+++	0,20	○
132010034	BUC-S25-L30-C08-T09	3201	□25	30	8	9	+++	0,20	○
132011834	BUC-S25-L30-C08-T16	3201	□25	30	8	16	+++	0,20	○
132011134	BUC-S25-L30-C08-T25	3201	□25	30	8	25	+++	0,20	○
132030234	BUC-S30-L30-C08-T04	3201	□30	30	8	4	+++	0,23	○
132022834	BUC-S30-L30-C08-T09	3201	□30	30	8	9	+++	0,23	○
132022934	BUC-S30-L30-C08-T16	3201	□30	30	8	16	+++	0,23	○
132023034	BUC-S30-L30-C08-T25	3201	□30	30	8	25	+++	0,23	○
132030334	BUC-S35-L30-C08-T04	3201	□35	30	8	4	+++	0,26	○
132023134	BUC-S35-L30-C08-T09	3201	□35	30	8	9	+++	0,26	○
132023234	BUC-S35-L30-C08-T16	3201	□35	30	8	16	+++	0,26	○
132023334	BUC-S35-L30-C08-T25	3201	□35	30	8	25	+++	0,26	○
132023434	BUC-S40-L30-C08-T16	3201	□40	30	8	16	+++	0,30	○
132030434	BUC-S40-L30-C08-T25	3201	□40	30	8	25	+++	0,30	○
132010134	BUC-S40-L30-C08-T36	3201	□40	30	8	36	+++	0,30	○
132005634	BUC-S40-L30-C08-T64	3201	□40	30	8	64	+++	0,30	○

Stock item | Produto de stock | Itens de stock

○ Available under request | Disponível sobre consulta | Disponible bajo consulta

Note: Other dimensions available under request | Outras dimensões disponíveis sob consulta | Otras dimensiones disponibles bajo consulta

Bush "Vistas" Type | Bujarda Tipo Vista

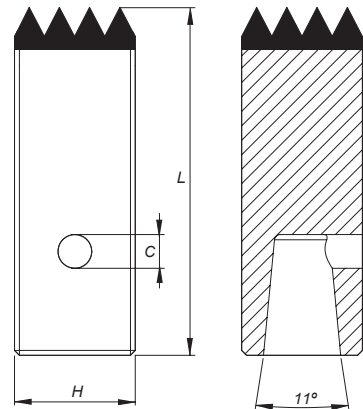
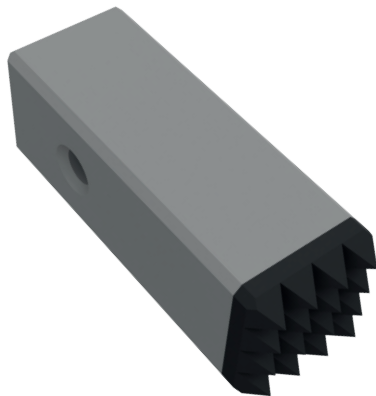

Order code Código de artigo Código producto	Reference Referência Referencia	Code Type Rúbrica artigo Tipo de código	Technical Information Informação Técnica Información Técnica					± Kg	Stock
			H (mm)	L (mm)	C (mm)	T	Hardness		
132008734	BUV-S25-L72,5-T04	3201	□ 25	72,5	Ø 7	4	++++	0,30	○
132008034	BUV-S25-L72,5-T09	3201	□ 25	72,5	Ø 7	9	++++	0,30	○
132001534	BUV-S25-L72,5-T16	3201	□ 25	72,5	Ø 7	16	++++	0,30	○
132001634	BUV-S25-L72,5-T25	3201	□ 25	72,5	Ø 7	25	++++	0,30	○
132001734	BUV-S25-L72,5-T36	3201	□ 25	72,5	Ø 7	36	++++	0,30	○
132010334	BUV-S30-L72,5-T09	3201	□ 30	72,5	Ø 7	9	++++	0,35	○
132023534	BUV-S30-L72,5-T16	3201	□ 30	72,5	Ø 7	16	++++	0,35	○
132023634	BUV-S30-L72,5-T25	3201	□ 30	72,5	Ø 7	25	++++	0,35	○
132023734	BUV-S30-L72,5-T36	3201	□ 30	72,5	Ø 7	36	++++	0,35	○

⊗ Stock item | Produto de stock | Itens de stock

○ Available under request | Disponível sobre consulta | Disponible bajo consulta

Note: Other dimensions available under request | Outras dimensões disponíveis sob consulta | Otras dimensiones disponibles bajo consulta

Codification for Hammers | Codificação de Pícolas | Codificación de Pícolas

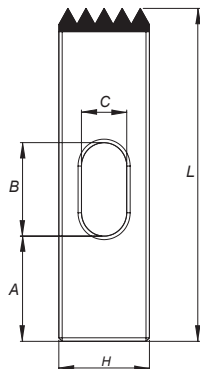

Example | Exemplo | Ejemplo

PIC	1 - Tool Ferramenta Herramienta
PIC	Hammer Picola Picola
L142,5	2 - Length [L measure] Comprimento [cota L] Longitud [medida L]
Lxxx	Length [mm] Comprimento [mm] Longitud [mm]
H40	3 - Side [H measure] Lado [cota H] Lado [medida H]
Hxx	Side [mm] Lado [mm] Lado [mm]
T16	4 - Plate Placa Placa
Txx	Nº of Teeth Nº de dentes Nº de dientes

Hammer | Picola

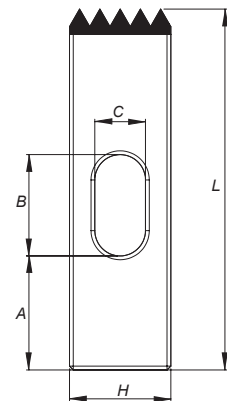
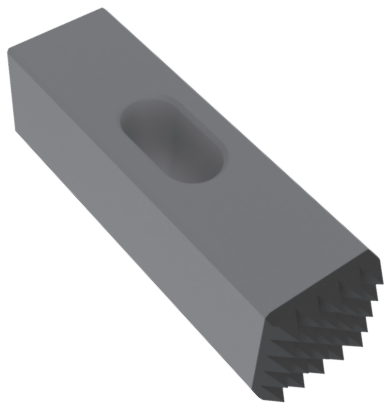

Order code Código de artigo Código producto	Reference Referência Referencia	Code Type Rúbrica artigo Tipo de código	Technical Information Informação Técnica Información Técnica							± Kg	Stock
			L (mm)	H (mm)	A (mm)	B (mm)	C (mm)	T	Hardness		
132004834	PIC-L142,5-H40-T16	3201	142,5	□ 40	47,25	32	20	16	++++	1,55	☼
132004934	PIC-L142,5-H40-T25	3201	142,5	□ 40	47,25	32	20	25	++++	1,58	☼

☼ Stock item | Produto de stock | Itens de stock

○ Available under request | Disponível sobre consulta | Disponible bajo consulta

Note: Other dimensions available under request | Outras dimensões disponíveis sob consulta | Otras dimensiones disponibles bajo consulta



Drilling Equipment

Finishing Stone Tools

Splitting Tools

Inserts

Codification for Chisels and Pitchers | Codificação de Cinzeis e Escacilhadores | Codificación de Cinceles y Escafiladores

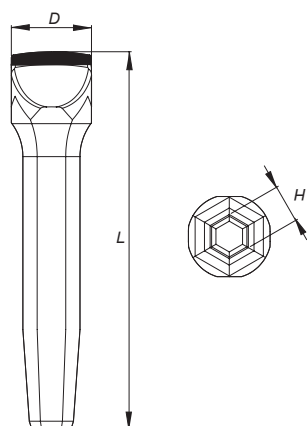

Drilling Equipment

Finishing Stone Tools

Splitting Tools

Inserts

Example | Exemplo | Ejemplo

CIZ	1 - Tool Ferramenta Herramienta
CIZ	Chisel Cinzel Cincel
ESC	Pitchers Escacilhador Escafiladores
P	2 -Type Tipo Tipo
P	Pneumatic Pneumático Neumático
M	Manual Manual Manual
	Omitted if Pitcher Omitido se Escacilhador Omitido si es Escafilador
L170	3 - Length [L measure] Comprimento [cota L] Longitud [medida L]
Lxxx	Length [mm] Comprimento [mm] Longitud [mm]
D36	4 - Head Width [D measure] Largura da Cabeça [cota D] Anchura de la Cabeza [medida D]
Dxx	Head Width [mm] Largura da Cabeça [mm] Anchura de la Cabeza [mm]
H15	5 - Body Geometry Geometria do Corpo Geometria del Cuerpo
Hxx	Hexagonal [mm] Hexagonal [mm] Hexágono [mm]
7	6 -Angle Ângulo Ángulo
	Omitted Omitido Omitido
7	Angle value Valor do Ângulo Valor del ángulo

Chisel Bit Monoblock without Radius | Cinzel Monoblock Recta sem Raio | Cincel Monoblock Recta sin Rayo

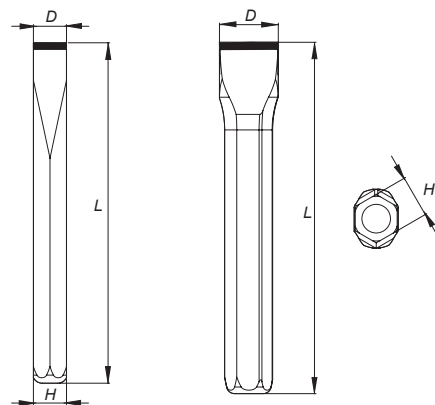
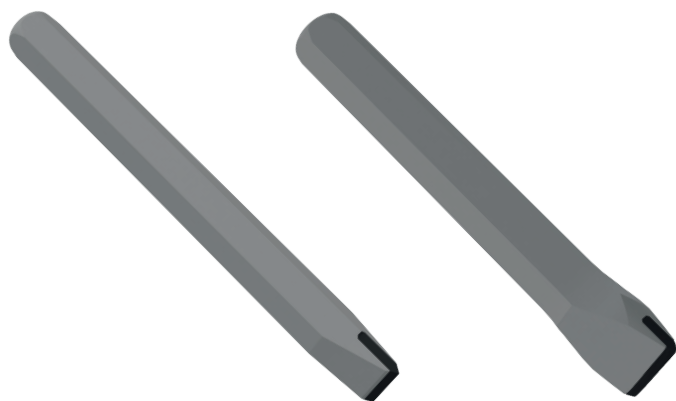

Order code Código de artigo Código producto	Reference Referência Referencia	Code Type Rúbrica artigo Tipo de código	Technical Information Informação Técnica Información Técnica				± Kg	Stock
			L (mm)	H (mm)	D (mm)	Hardness		
1330067E5	CIZ-M-L205-D20-H20	3204	205	20	20	⊕⊕	0,15	○
1330008E5	CIZ-M-L210-D36-H22	3204	210	22	36	⊕⊕	0,62	○

Stock item | Produto de stock | Itens de stock

Available under request | Disponível sobre consulta | Disponible bajo consulta

Note: Other dimensions available under request | Outras dimensões disponíveis sob consulta | Otras dimensiones disponibles bajo consulta

Chisel Bit Monoblock - Pneumatic | Cinzel Monoblock Pneumático | Cincel Monoblock Neumático

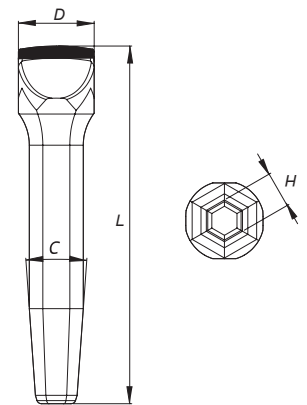

Order code Código de artigo Código producto	Reference Referência Referencia	Code Type Rúbrica artigo Tipo de código	Technical Information Informação Técnica Información Técnica					± Kg	Stock
			L (mm)	H (mm)	D (mm)	C (°)	Hardness		
1330009E5	CIZ-P-L170-D36-H15-7	3204	170	15	36	7	++	0,53	Ⓢ

Ⓢ Stock item | Produto de stock | Itens de stock

○ Available under request | Disponível sobre consulta | Disponible bajo consulta

Note: Other dimensions available under request | Outras dimensões disponíveis sob consulta | Otras dimensiones disponibles bajo consulta

Pitcher | Escacilhador | Escafilador

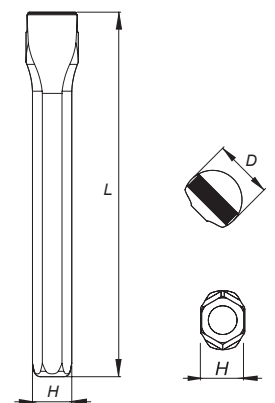

Order code Código de artigo Código producto	Reference Referência Referencia	Code Type Rúbrica artigo Tipo de código	Technical Information Informação Técnica Información Técnica				± Kg	Stock
			L (mm)	H (mm)	D (mm)	Hardness		
1330018E5	ESC-L270-D40-H25	3205	270	25	40	++	1,24	Ⓢ

Ⓢ Stock item | Produto de stock | Itens de stock

○ Available under request | Disponível sobre consulta | Disponible bajo consulta

Note: Other dimensions available under request | Outras dimensões disponíveis sob consulta | Otras dimensiones disponibles bajo consulta

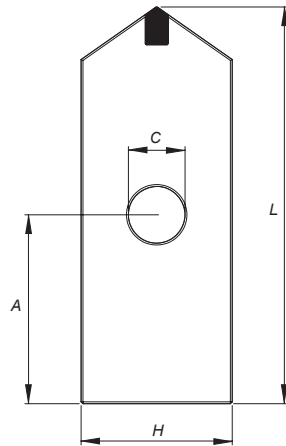

Example | Exemplo | Ejemplo

MCO	1 - Tool Ferramenta Herramienta
MCO	Stone Bundle Maço Maço
L180	2 - Length [L measure] Comprimento [cota L] Longitud [medida L]
Lxxx	Length [mm] Comprimento [mm] Longitud [mm]
H75	3 - Side [H measure] Lado [cota H] Lado [medida H]
Hxx	Side [mm] Lado [mm] Lado [mm]
A060	4 - Dist. of Hole to the Base [A measure] Distância do Furo à Base [cota A] Distancia del Agujero a la Base [medida A]
Axxx	Value of "A" [mm] Valor de "A" [mm] Valor de "A" [mm]
B50	5 - Slot [B measure] Rasgo [cota B] Rasgo [medida B]
Bxx	Slot Length [mm] Comprimento do Rasgo [mm] Longitud del Rasgo [mm]
C22	6 - Hole [C measure] Furo [cota C] Agujero [medida C]
Cxx	Hole Diameter Diâmetro Furo Diámetro Agujero



Drilling Equipment

Finishing Stone Tools

Splitting Tools

Inserts

Stone Stamp with Hole | Maço com Furo | Maço con Agujero

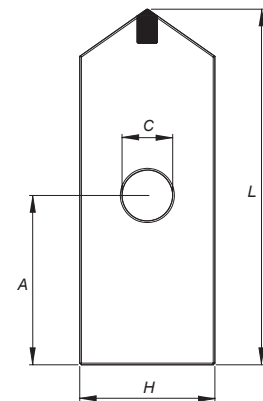
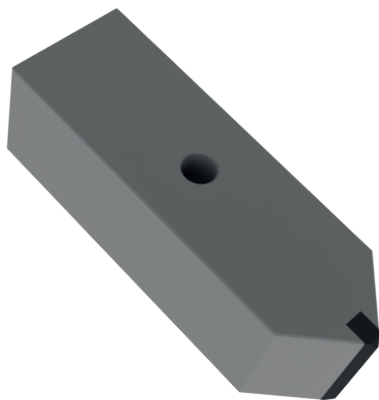

Order code Código de artigo Código producto	Reference Referência Referencia	Code Type Rúbrica artigo Tipo de código	Technical Information Informação Técnica Información Técnica					± Kg	Stock
			L (mm)	H (mm)	A (mm)	C (mm)	Hardness		
133002929	MCO-L190-H70-A084-C21	3202	190	□70	84	∅ 21	+	6,50	○
133009529	MCO-L190-H70-A084-C25	3202	190	□70	84	∅ 25	+	6,50	○
133009429	MCO-L210-H80-A100-C30	3202	210	□80	100	∅ 30	+	9,00	○

Stock item | Produto de stock | Itens de stock

Available under request | Disponível sobre consulta | Disponible bajo consulta

Note: Other dimensions available under request | Outras dimensões disponíveis sob consulta | Otras dimensiones disponibles bajo consulta

Stone Stamp with Slot | Maço com Rasgo | Maço con Rasgo

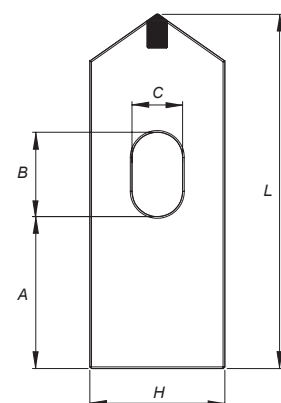
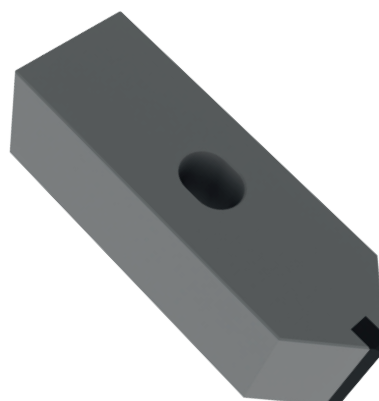

Order code Código de artigo Código producto	Reference Referência Referencia	Code Type Rúbrica artigo Tipo de código	Technical Information Informação Técnica Información Técnica					± Kg	Stock	
			L (mm)	H (mm)	A (mm)	B (mm)	C (mm)			Hardness
133003029	MCO-L180-H75-A060-B50-C22	3202	180	□75	60	50	22	+	6,50	○
133004229	MCO-L190-H70-A060-B48-C22	3202	190	□70	60	48	22	+	6,50	○
133009329	MCO-L190-H70-A060-B50-C25	3202	190	□70	60	50	25	+	6,50	○
133007629	MCO-L210-H80-A090-B50-C30	3202	210	□80	90	50	30	+	8,50	○

Stock item | Produto de stock | Itens de stock

Available under request | Disponível sobre consulta | Disponible bajo consulta

Note: Other dimensions available under request | Outras dimensões disponíveis sob consulta | Otras dimensiones disponibles bajo consulta

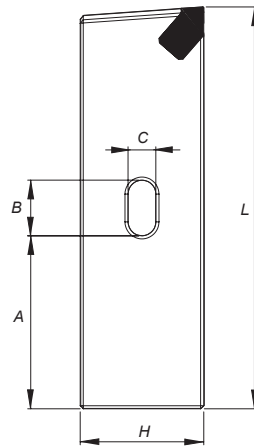

Example Exemplo Ejemplo	MCA	1 - Tool Ferramenta Herramienta
	MCA	Stone Hammer Maceta Maceta
	L110	2 - Length [L measure] Comprimento [cota L] Longitud [medida L]
	Lxxx	Length [mm] Comprimento [mm] Longitud [mm]
	H45	3 - Side [H measure] Lado [cota H] Lado [medida H]
	Hxx	Side [mm] Lado [mm] Lado [mm]
	A046	4 - Dist. of Slot to the Base [A measure] Distância do Rasgo à Base [cota A] Distancia del Rasgo a la Base [medida A]
Axxx	Value of "A" [mm] Valor de "A" [mm] Valor de "A" [mm]	
B18	5 - Slot [B measure] Rasgo [cota B] Rasgo [medida B]	
Hxx	Slot Length [mm] Comprimento do Rasgo [mm] Longitud del Rasgo [mm]	
C09	6 - Slot [C measure] Rasgo [cota C] Rasgo [medida C]	
Cxx	Slot Width [mm] Largura do Rasgo [mm] Anchura del Rasgo [mm]	
L	7 - Right / Left Direita / Esquerda Derecho / Izquierdo	
R	Right Direita Derecho	
L	Left Esquerda Izquierdo	

Stone Hammer | Maceta

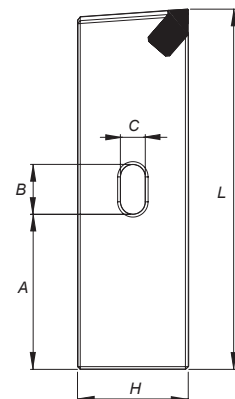
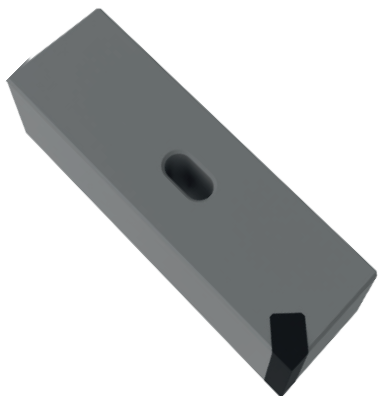

Order code Código de artigo Código producto	Reference Referência Referencia	Code Type Rúbrica artigo Tipo de código	Technical Information Informação Técnica Información Técnica							± Kg	Stock
			L (mm)	H (mm)	A (mm)	B (mm)	C (mm)	Pos. *	Hardness		
133009628	MCA-L110-H45-A46-B18-C09-R	3203	110	□45	46	18	9	R	+++	1,50	○
133009728	MCA-L110-H45-A46-B18-C09-L	3203	110	□45	46	18	9	L	+++	1,50	○
133009828	MCA-L112-H40-A47-B18-C09-R	3203	112	□40	47	18	9	R	+++	1,50	○
133009928	MCA-L112-H40-A47-B18-C09-L	3203	112	□40	47	18	9	L	+++	1,50	○
133002828	MCA-L120-H45-A50-B20-C10-R	3203	120	□45	50	20	10	R	+++	1,81	○
133010028	MCA-L120-H45-A50-B20-C10-L	3203	120	□45	50	20	10	L	+++	1,81	○
133002428	MCA-L130-H40-A56-B18-C09-R	3203	130	□40	56	18	9	R	+++	1,60	○
133002328	MCA-L130-H40-A56-B18-C09-L	3203	130	□40	56	18	9	L	+++	1,60	○
133002128	MCA-L138-H40-A60-B18-C09-R	3203	138	□40	60	18	9	R	+++	1,70	○
133002028	MCA-L138-H40-A60-B18-C09-L	3203	138	□40	60	18	9	L	+++	1,70	○
133002228	MCA-L138-H40-A58-B23-C17-R	3203	138	□40	58	23	17	R	+++	1,70	○
133010128	MCA-L138-H40-A58-B23-C17-L	3203	138	□40	58	23	17	L	+++	1,70	○
133010328	MCA-L140-H40-A61-B18-C09-R	3203	140	□40	61	18	9	R	+++	1,70	○
133010428	MCA-L140-H40-A61-B18-C09-L	3203	140	□40	61	18	9	L	+++	1,70	○
133002528	MCA-L150-H40-A66-B18-C09-R	3203	150	□40	66	18	9	R	+++	1,80	○
133010228	MCA-L150-H40-A66-B18-C09-L	3203	150	□40	66	18	9	L	+++	1,80	○

☺ Stock item | Produto de stock | Itens de stock

○ Available under request | Disponível sobre consulta | Disponible bajo consulta

Note: Other dimensions available under request | Outras dimensões disponíveis sob consulta | Otras dimensiones disponibles bajo consulta

*Position / Posição / Posición :
R: Right / Direito / Derecho
L: Left / Esquerda / Izquierdo



SPLITTING TOOLS

Top Splitting	Bottom Splitting	Crush Tool Barmac
		
Pag. 52	Pag. 55	Pag. 58

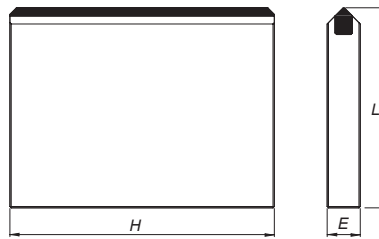

L	1 - Tool Ferramenta Herramienta
L	Knife Lâmina Cuchilla
B	2 - Type Tipo Tipo
S	Top Superior Superior
B	Bottom Base Base
R	Crush Tool Barmac Raspa Barmac Raspa Barmac
0	3 - Slot Rasgo Rasgo
Fx	Central Hole if LS Furo central se LS Agujero central si es LS
R	Central slot if LS Rasgo central se LS Rasgo central si es LS
L	Lateral slot if LS Rasgo Lateral se LS Rasgo lateral si es LS
x	Holes nº if LB or LR Nº furos se LS ou LR Nº agujeros si LB o LR
PAK	4 - Machine Máquina Máquina
AMB	Amob Amob Amob
PAK	Pakon Pakon Pakon
VEN	Venâncio Venâncio Venâncio
STE	Steinex Steinex Steinex
PRO	Prosfeld Prosfeld Prosfeld
TEC	Techno Split Techno Split Techno Sp
XXX	Others Outras Otras
L180	5 - Length (L measure) Comprimento (cota L) Longitud (medida L)
LXXX	Value of "L" [mm] Valor de "L" [mm] Valor de "L" [mm]
H210	6 - Side (H measure) Lado (cota H) Lado (medida H)
HXXX	Value of "H" [mm] Valor de "H" [mm] Valor de "H" [mm]
E40	7 - Thickness (E measure) Espessura (cota E) Espesor (medida E)
EXX	Value of "E" [mm] Valor de "E" [mm] Valor de "E" [mm]
	8 - Insert Pastilha Plaquita
R	Radius Raio Rayo
	Omitted if without radius Omitido se direito Omitido si sin rayo

Top Splitting Tool with Lateral Slot with Radius | Lâmina Superior em Raio com Rasgo Lateral | Cuchilla Superior en Rayo con Rasgo Lateral

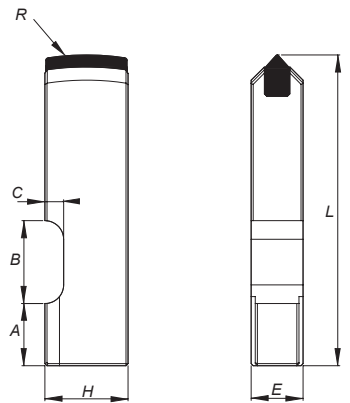
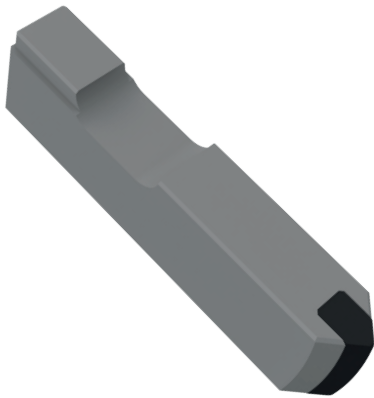

Order code Código de artigo Código producto	Reference Referência Referencia	Code Type Rúbrica artigo Tipo de código	Dimensions Dimensões Dimensiones (mm)							± Kg	Stock
			L	H	E	A	B	C	R		
1330082E5	LSL-STE-L120-H50-E25-R	3301	120	50	25	25	44	9	200	1,08	○
1330034E5	LSL-STE-L150-H40-E25-R	3301	150	40	25	30	40	9	125	1,08	⊗
1330050E5	LSL-STE-L150-H50-E25-R	3301	150	50	25	30	40	9	200	1,40	○
1330035E5	LSL-STE-L150-H50-E30-R	3301	150	50	30	30	40	9	125	1,65	○
1330039E5	LSL-STE-L200-H50-E30-R	3301	200	50	30	38	49	10	125	2,16	○
1330010E5	LSL-PAK-L195-H50-E30-R	3301	195	50	30	38	49	9	200	2,14	⊗
1330013E5	LSL-PAK-L200-H50-E30-R	3301	200	50	30	38	55	9	125	2,20	○
1330037E5	LSL-VEN-L150-H50-E30-R	3301	150	50	30	30	40	9	125	1,65	○
1330038E5	LSL-VEN-L200-H50-E30-R	3301	200	50	30	40	50	9	125	2,15	○

⊗ Stock item | Produto de stock | Itens de stock

○ Available under request | Disponível sobre consulta | Disponible bajo consulta

Note: Other dimensions available under request | Outras dimensões disponíveis sob consulta | Otras dimensiones disponibles bajo consulta

Top Splitting Tool with Hole with Radius | Lâmina Superior em Raio com Furo | Cuchilla Superior en Rayo con Agujero

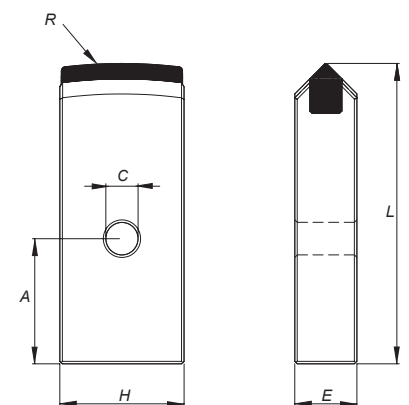
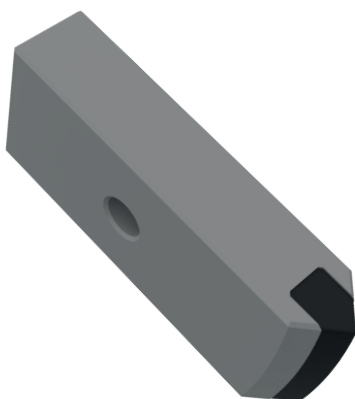

Order code Código de artigo Código producto	Reference Referência Referencia	Code Type Rúbrica artigo Tipo de código	Dimensions Dimensões Dimensiones (mm)						± Kg	Stock
			L	H	E	A	C	R		
1330112E5	LSF1-AMB-L130-H50-E25-R	3301	130	50	25	50	∅ 12,5	200	1,20	○
1330016E5	LSF1-VEN-L105-H50-E25-R	3301	105	50	25	50	∅ 13,0	200	0,98	○
1330055E5	LSF1-VEN-L120-H50-E25-R	3301	120	50	25	50	∅ 13,0	200	1,11	○
1330105E5	LSF1-VEN-L125-H50-E25-R	3301	125	50	25	50	∅ 13,0	200	1,16	○
1330106E5	LSF1-VEN-L145-H50-E25-R	3301	145	50	25	50	∅ 13,0	200	1,30	○

⊗ Stock item | Produto de stock | Itens de stock

○ Available under request | Disponível sobre consulta | Disponible bajo consulta

Note: Other dimensions available under request | Outras dimensões disponíveis sob consulta | Otras dimensiones disponibles bajo consulta

Drilling Equipment

Finishing Stone Tools

Splitting Tools

Inserts

Top Splitting Tool with Central Slot with Radius | Lâmina Superior em Raio com Rasgo Central | Cuchilla Superior en Rayo con Rasgo Central

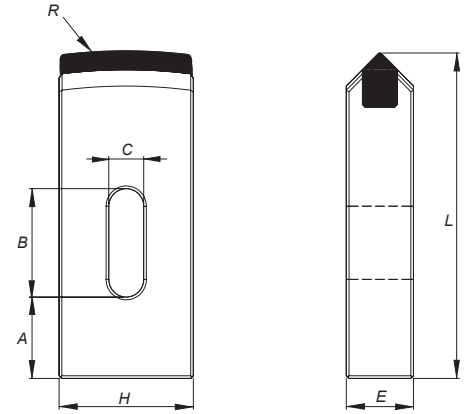
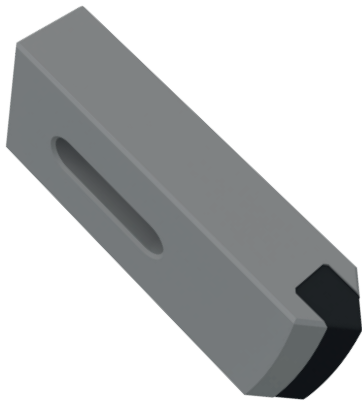

Order code Código de artigo Código producto	Reference Referência Referencia	Code Type Rúbrica artigo Tipo de código	Dimensions Dimensões Dimensiones (mm)								± Kg	Stock
			L	H	E	A	B	C	R			
1330045E5	LSR-PRO-L105-H40-E20-R	3301	105	40	20	22,5	30	18,3	140	0,60	○	
1330051E5	LSR-PRO-L135-H40-E20-R	3301	135	40	20	30	50	18,3	140	0,75	○	
1330014E5	LSR-PAK-L120-H50-E25-R	3301	120	50	25	20	45	12	200	1,06	⊗	
1330113E5	LSR-PAK-L120-H50-E30-R	3301	120	50	30	20	45	12	125	1,23	○	
1330056E5	LSR-AMB-L105-H50-E25-R	3301	105	50	25	30	30	12	200	0,95	○	
1330012E5	LSR-AMB-L120-H50-E25-R	3301	120	50	25	20	45	12	200	1,06	○	
1330059E5	LSR-AMB-L120-H52-E25-R	3301	120	52	25	20	45	12	125	1,10	○	
1330079E5	LSR-VEN-L145-H50-E25-R	3301	145	50	25	40	45	12	200	1,27	○	

⊗ Stock item | Produto de stock | Itens de stock ○ Available under request | Disponível sobre consulta | Disponible bajo consulta

Note: Other dimensions available under request | Outras dimensões disponíveis sob consulta | Otras dimensiones disponibles bajo consulta

Top Splitting Tool with Slot or Hole without Radius | Lâmina Superior Recta com Rasgo ou Furo | Cuchilla Superior Recta con Rasgo o Agujero

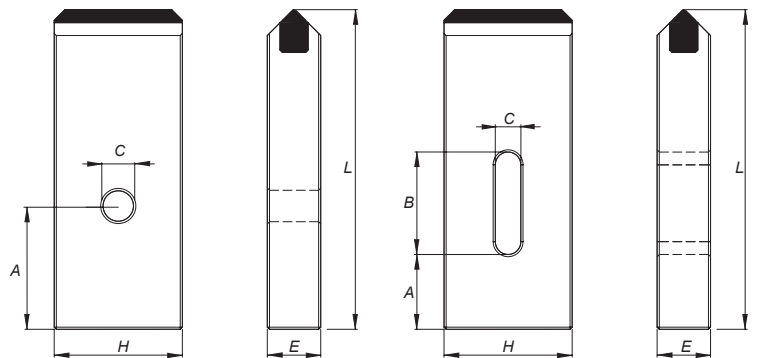
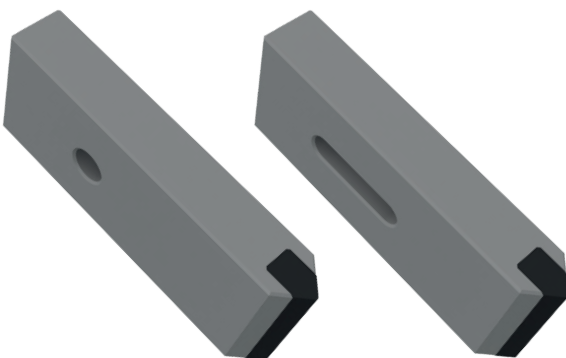

Order code Código de artigo Código producto	Reference Referência Referencia	Code Type Rúbrica artigo Tipo de código	Dimensions Dimensões Dimensiones (mm)							± Kg	Stock
			L	H	E	A	B	C			
1330015E5	LSF1-VEN-L125-H50-E25	3301	125	50	25	50	-	∅ 13	1,10	○	
1330053E5	LSL-STE-L150-H40-E25	3301	150	40	25	30	40	9	1,08	○	
1330074E5	LSR-PRO-L140-H40-E20	3301	140	40	20	32	48	6	0,78	○	
1330054E5	LSR-PRO-L180-H60-E4	3301	180	60	40	35	71	26	3,05	○	

⊗ Stock item | Produto de stock | Itens de stock ○ Available under request | Disponível sobre consulta | Disponible bajo consulta

Note: Other dimensions available under request | Outras dimensões disponíveis sob consulta | Otras dimensiones disponibles bajo consulta

Drilling Equipment

Finishing Stone Tools

Splitting Tools

Inserts

Bottom Splitting Tool without Hole and Radius | Lâmina Base Recta sem Furos | Cuchilla Base Recta sin Agujeros

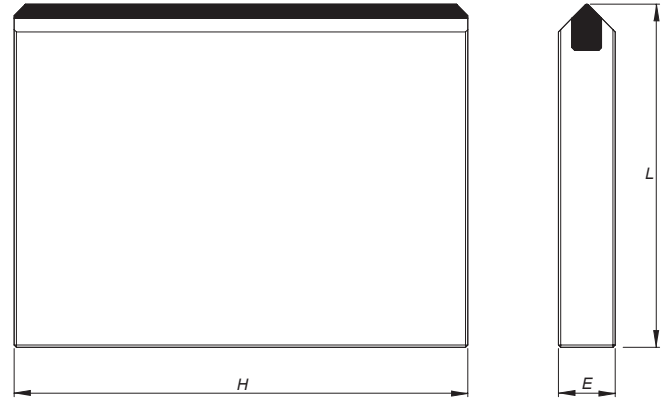
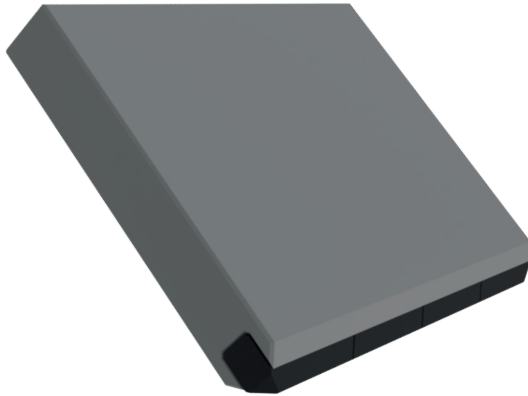

Order code Código de artigo Código producto	Reference Referência Referencia	Code Type Rúbrica artigo Tipo de código	Dimensions Dimensões Dimensiones (mm)				± Kg	Stock
			L	H	E			
1330062E5	LBO-PAK-L127-H260-E30	3301	127	260	30	8,25	○	
1330002E5	LBO-PAK-L180-H210-E40	3301	180	210	40	11,20	○	
1330047E5	LBO-VEN-L120-H500-E25	3301	120	500	25	11,10	○	
1320004E5	LBO-STE-L150-H240-E25	3301	150	240	25	6,60	○	
1320005E5	LBO-TEC-L150-H200-E25	3301	150	200	25	5,55	○	

Stock item | Produto de stock | Itens de stock Available under request | Disponível sobre consulta | Disponible bajo consulta

Note: Other dimensions available under request | Outras dimensões disponíveis sob consulta | Otras dimensiones disponibles bajo consulta

Bottom Splitting Tool without Hole with Radius | Lâmina Base em Raio sem Furos | Cuchilla Base en Rayo sin Agujeros

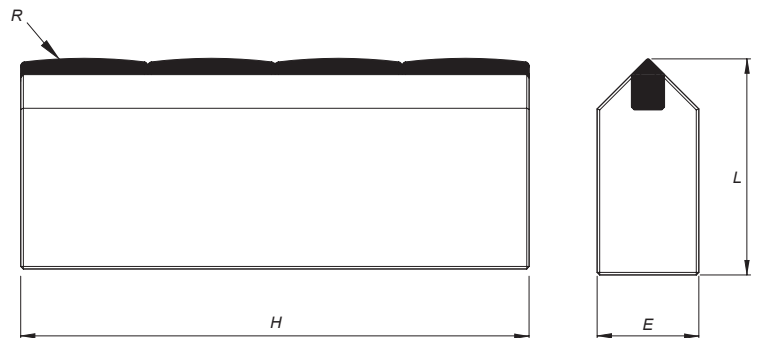
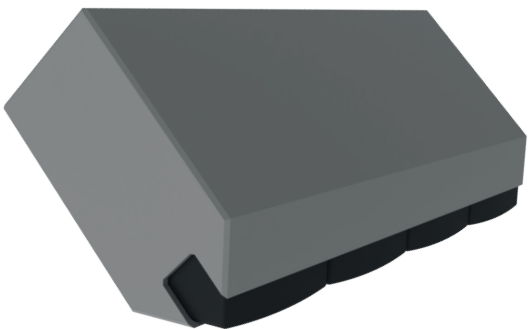

Order code Código de artigo Código producto	Reference Referência Referencia	Code Type Rúbrica artigo Tipo de código	Dimensions Dimensões Dimensiones (mm)				± Kg	Stock
			L	H	E	R		
1320002E5	LBO-AMB-L085-H200-E40-R	3301	85	200	40	200	5,05	○

Stock item | Produto de stock | Itens de stock Available under request | Disponível sobre consulta | Disponible bajo consulta

Note: Other dimensions available under request | Outras dimensões disponíveis sob consulta | Otras dimensiones disponibles bajo consulta



Drilling Equipment

Finishing Stone Tools

Splitting Tools

Inserts

Bottom Splitting Tool with 1 Hole with Radius | Lâmina Base em Raio com 1 Furo | Cuchilla Base en Rayo con 1 Agujero

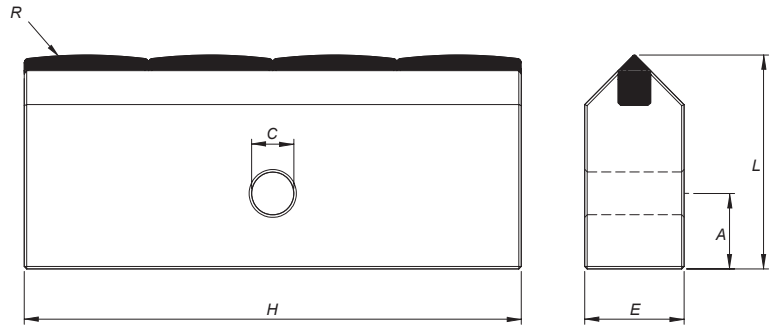
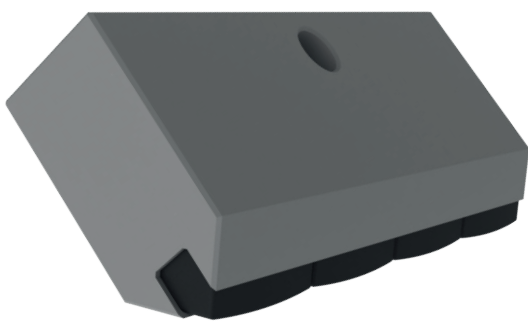

Order code Código de artigo Código producto	Reference Referência Referencia	Code Type Rúbrica artigo Tipo de código	Dimensions Dimensões Dimensiones (mm)						± Kg	Stock
			L	H	E	A	C	R		
1330003E5	LBF1-VEN-L085-H200-E40-R	3301	85	200	40	30	Ø 11	200	5,05	○

☑ Stock item | Produto de stock | Itens de stock

○ Available under request | Disponível sobre consulta | Disponible bajo consulta

Note: Other dimensions available under request | Outras dimensões disponíveis sob consulta | Otras dimensiones disponibles bajo consulta

Bottom Splitting Tool with 2 Holes with Radius | Lâmina Base em Raio com 2 Furos | Cuchilla Base en Rayo con 2 Agujeros

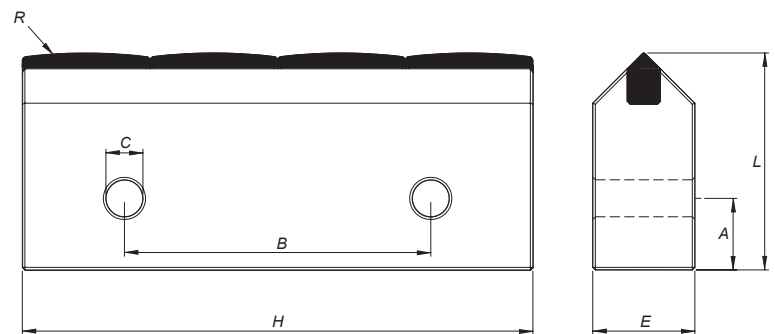
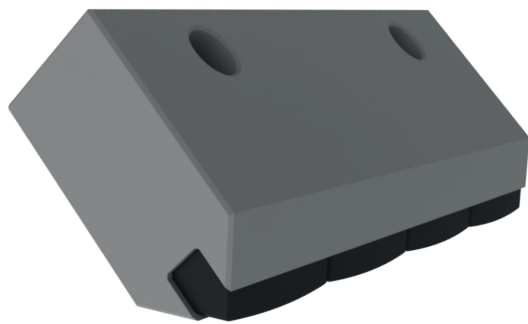

Order code Código de artigo Código producto	Reference Referência Referencia	Code Type Rúbrica artigo Tipo de código	Dimensions Dimensões Dimensiones (mm)						± Kg	Stock	
			L	H	E	A	B	C			R
1330040E5	LBF2-AMB-L085-H200-E40-R	3301	85	200	40	16	120	Ø 16,5	200	5,00	○

☑ Stock item | Produto de stock | Itens de stock

○ Available under request | Disponível sobre consulta | Disponible bajo consulta

Note: Other dimensions available under request | Outras dimensões disponíveis sob consulta | Otras dimensiones disponibles bajo consulta

Bottom Splitting Tool with 3 Holes with Radius | Lâmina Base em Raio com 3 Furos | Cuchilla Base en Rayo con 3 Agujeros

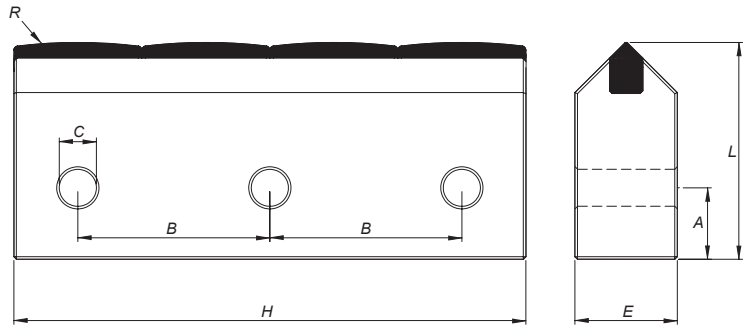
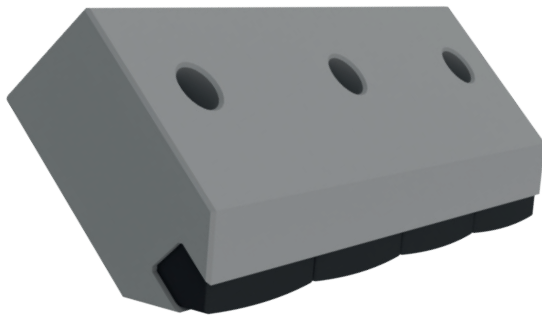

Order code Código de artigo Código producto	Reference Referência Referencia	Code Type Rúbrica artigo Tipo de código	Dimensions Dimensões Dimensiones (mm)								± Kg	Stock
			L	H	E	A	B	C	R			
1330041E5	LBF3-VEN-L085-H200-E40-R	3301	85	200	40	28	75	Ø 14,5	200	4,95	○	
1330107E5	LBF3-AMB-L085-H200-E40-R	3301	85	200	40	16	75	Ø 16,5	200	4,95	○	

⊗ Stock item | Produto de stock | Itens de stock

○ Available under request | Disponível sobre consulta | Disponible bajo consulta

Note: Other dimensions available under request | Outras dimensões disponíveis sob consulta | Otras dimensiones disponibles bajo consulta

Bottom Splitting Tool with 5 Holes with Radius | Lâmina Base em Raio com 5 Furos | Cuchilla Base en Rayo con 5 Agujeros

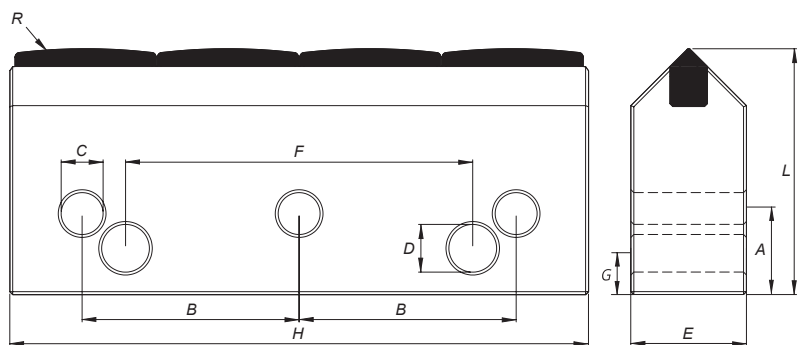
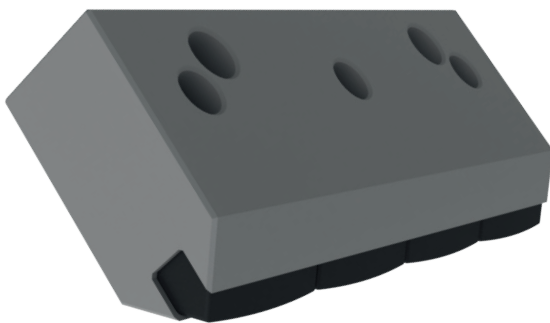

Order code Código de artigo Código producto	Reference Referência Referencia	Code Type Rúbrica artigo Tipo de código	Dimensions Dimensões Dimensiones (mm)										± Kg	Stock
			L	H	E	A	G	B	F	C	D	R		
1330120E5	LBF5-UNI-L85-H200-E40-R	3301	85	200	40	28	16	75	120	Ø14,5	Ø16,5	200	4,80	⊗

⊗ Stock item | Produto de stock | Itens de stock

○ Available under request | Disponível sobre consulta | Disponible bajo consulta

Note: Other dimensions available under request | Outras dimensões disponíveis sob consulta | Otras dimensiones disponibles bajo consulta

Splitting Tools | Ferramentas para Máquinas de Pedra | Herramientas para las Máquinas de Piedra

Bottom Splitting Tool with 4 Holes without Radius | Lâmina Base Recta com 4 Furos | Cuchilla Base Recta con 4 Agujeros

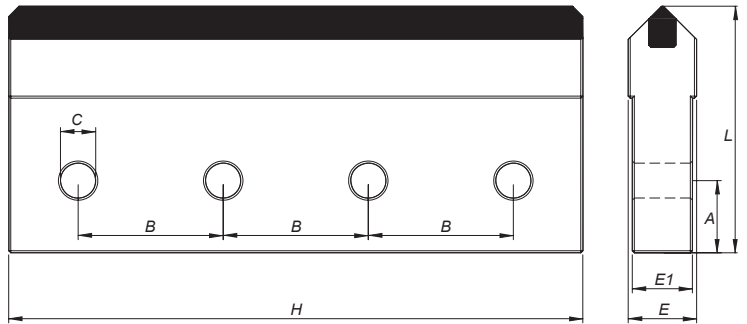
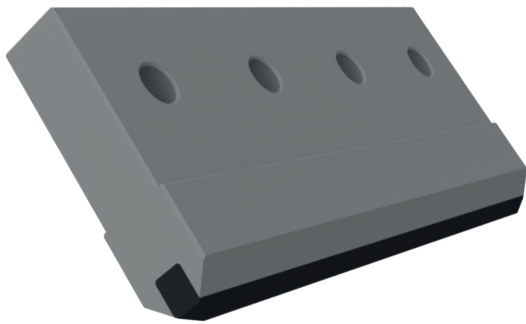

Order code Código de artigo Código producto	Reference Referência Referencia	Code Type Rúbrica artigo Tipo de código	Dimensions Dimensões Dimensiones (mm)							± Kg	Stock
			L	H	E	E1	A	B	C		
1330044E5	LBF4-AMB-L120-H277-E33/29	3301	120	277	33	29	35	70	Ø 16,5	7,80	○

Stock item | Produto de stock | Itens de stock

Available under request | Disponível sobre consulta | Disponible bajo consulta

Note: Other dimensions available under request | Outras dimensões disponíveis sob consulta | Otras dimensiones disponibles bajo consulta

Crush Tool Barmac | Lâmina Raspa Barmac | Cuchilla Raspa Barmac

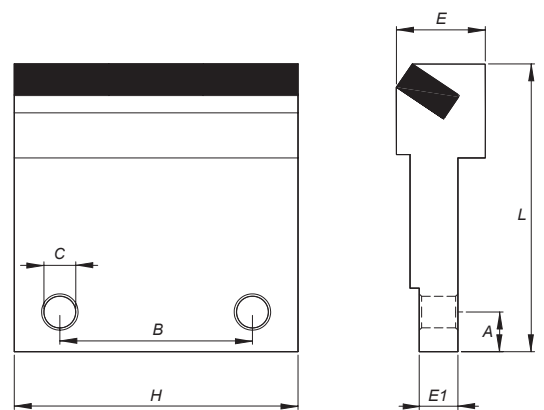

Order code Código de artigo Código producto	Reference Referência Referencia	Code Type Rúbrica artigo Tipo de código	Dimensions Dimensões Dimensiones (mm)							± Kg	Stock
			L	H	E	E1	A	B	C		
133010933	LR2-BAR-L127-H106-E39/17	3301	127	106	39	17	17,5	43	Ø 14	2,65	○
133011033	LR2-BAR-L127-H124-E39/17	3301	127	124	39	17	17,5	84	Ø 14	3,05	○
133011133	LR2-BAR-L127-H163-E39/17	3301	127	163	39	17	17,5	101	Ø 14	4,01	○



Stock item | Produto de stock | Itens de stock

Available under request | Disponível sobre consulta | Disponible bajo consulta

Note: Other dimensions available under request | Outras dimensões disponíveis sob consulta | Otras dimensiones disponibles bajo consulta

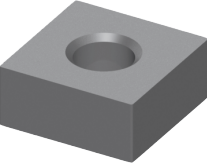

INSERTS

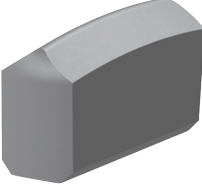
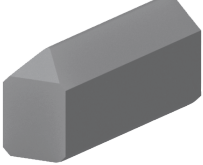
Inserts for Chainsaw	Buttons	Plates	Inserts for Integral Drill	Inserts for Splitting
				
Pag. 61	Pag. 62	Pag. 63	Pag. 64	Pag. 65

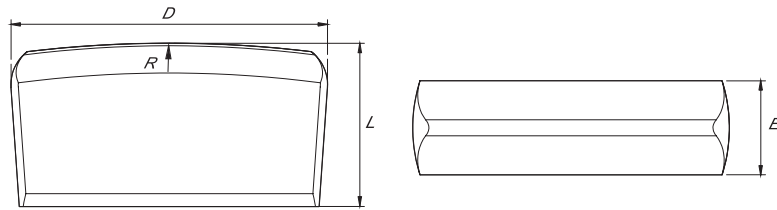

ROCK

1 - Insert Type | Tipo de Pastilha | Tipo de Plaquita

P-BU Buttons for Bushes | Pinos para Bujardas | Botones para Bujardas

T-BU Plates for Bushes | Placas para Bujardas | Placas para Bujardas

ROCK Inserts for Integral Drill Rods | Pastilhas para Barrenas | Plaquitas para Barrenas

LAMIN. Inserts for Splitting Tools | Pastilhas para Lâminas | Plaquitas para Cuchillas

SERR. Inserts for Chainsaw Cutters | Pastilhas para Serrotes | Plaquitas para Sierras

D_x_x_

2 - Dimensions | Dimensões | Dimensiones

D_x_ Diameter x Height | Diâmetro x Altura | Diámetro x Altura

S_x_ Square x Height | Quadrado x Altura | Cuadrado x Altura

D_x_x_ Diameter x Height x Thickness | Diâmetro x Altura x Espessura | Diámetro x Altura x Espesor

_x_x_ Width x Height x Thickness | Largura x Altura x Espessura | Anchura x Altura x Espesor

S_E_F Square - Thickness - Hole | Quadrado - Espessura - Furo | Cuadrado - Espesor - Agujero

R_

3 - Details | Particularidades | Detalles

°/° Top Angle / Bottom Angle | Ângulo Superior / Ângulo Inferior | Ángulo Superior / Ángulo Inferior

T_° Number of Teeth and Angle | Número de Dentes e Ângulo | Número de Dientes y Ángulo

R Radius | Raio | Rayo

R_/_° Radius and Angle | Raio e Ângulo | Rayo e Ángulo

C/CH With Chamfer | Com Chanfro | Con Bisel

S/CH Without Chamfer | Sem Chanfro | Sin Bisel

Omitted if without details | Omitido se sem particularidades | Omitido si sin detalles

Example | Exemplo | Ejemplo

Drilling Equipment

Finishing Stone Tools

Splitting Tools

Inserts

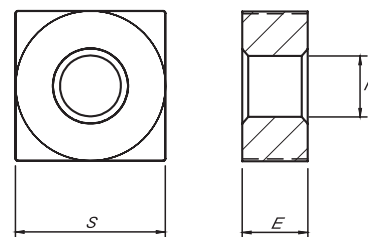
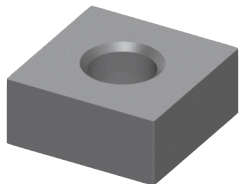

Order code Código de artigo Código producto	Reference Referência Referencia	Code Type Rúbrica artigo Tipo de código	Dimensions Dimensões Dimensiones				± Kg	Stock
			S (mm)	E (mm)	F (mm)	Edges		
139027933	SERR. F S12,7-E5,5-F5,16	3901	12,70	5,5	5,16	8	0,012	○
139020933	SERR. K S12,7-E6,0-F5,30	3901	12,70	6,0	5,20	4	0,012	○
139031733	SERR. G S13,15-E7,0-F5,20	3901	13,15	7,0	5,20	8	0,016	○

⊗ Stock item | Produto de stock | Itens de stock

○ Available under request | Disponível sobre consulta | Disponible bajo consulta

Note: Other dimensions available under request | Outras dimensões disponíveis sob consulta | Otras dimensiones disponibles bajo consulta

Buttons for Bushes | Pinos para Bujardas | Botones para Bujardas

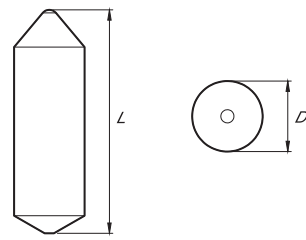

Order code Código de artigo Código producto	Reference Referência Referencia	Code Type Rúbrica artigo Tipo de código	Dimensions Dimensões Dimensiones		± Kg	Stock
			D (mm)	L (mm)		
139026133	P-BU-D3x13	3901	3,0	13	0,001	○
139000833	P-BU-D4,1x13	3901	4,1	13	0,002	⊗
139001033	P-BU-D5x13	3901	5,0	13	0,003	○
139001233	P-BU-D6x13	3901	6,0	13	0,004	⊗
139026213	P-BU-D7,5x13	3901	7,5	13	0,007	○
139026313	P-BU-D10x13	3901	10,0	13	0,014	○

⊗ Stock item | Produto de stock | Itens de stock

○ Available under request | Disponível sobre consulta | Disponible bajo consulta

Note: Other dimensions available under request | Outras dimensões disponíveis sob consulta | Otras dimensiones disponibles bajo consulta

Plates for Bushes | Placas para Bujardas

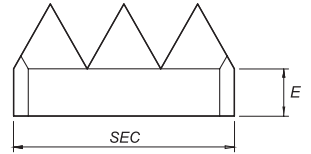
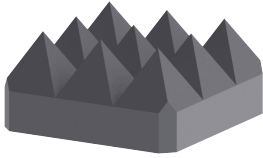

Order code Código de artigo Código producto	Reference Referência Referencia	Code Type Rúbrica artigo Tipo de código	Dimensions Dimensões Dimensiones			± Kg	Stock
			Sec. (mm)	E (mm)	Z		
139027734	T-BU-S15x3-T09 60°	3901	□15	3	9	0,015	○
139027834	T-BU-S15x3-T16 50°	3901	□15	3	16	0,015	○
139017834	T-BU-S20x3-T04 60°	3901	□20	3	4	0,030	○
139001834	T-BU-S20x3-T09 80°	3901	□20	3	9	0,026	○
139001734	T-BU-S20x3-T16 60°	3901	□20	3	16	0,027	○
139025734	T-BU-S20x3-T25 60°	3901	□20	3	25	0,025	○
139017734	T-BU-S25x3-T04 60°	3901	□25	3	4	0,065	○
139002434	T-BU-S25x3-T09 60°	3901	□25	3	9	0,050	○
139002134	T-BU-S25x3-T16 60°	3901	□25	3	16	0,045	⊗
139002234	T-BU-S25x3-T25 60°	3901	□25	3	25	0,042	⊗
139002734	T-BU-S25x3-T36 60°	3901	□25	3	36	0,040	○
139025834	T-BU-S30x3-T04 60°	3901	□30	3	4	0,081	○
139021234	T-BU-S30x3-T09 60°	3901	□30	3	9	0,079	○
139021334	T-BU-S30x3-T16 60°	3901	□30	3	16	0,069	○
139025934	T-BU-S30x3-T25 60°	3901	□30	3	25	0,062	○
139017234	T-BU-S30x3-T36 60°	3901	□30	3	36	0,060	○
139026034	T-BU-S35x3-T04 80°	3901	□35	3	4	0,101	○
139002534	T-BU-S35x3-T09 60°	3901	□35	3	9	0,098	○
139002834	T-BU-S35x3-T16 60°	3901	□35	3	16	0,088	○
139015434	T-BU-S35x3-T25 60°	3901	□35	3	25	0,092	○
139029234	T-BU-S40x3-T16 60°	3901	□40	3	16	0,142	⊗
139029134	T-BU-S40x3-T25 60°	3901	□40	3	25	0,128	⊗
139019034	T-BU-S40x3-T36 60°	3901	□40	3	36	0,119	○

⊗ Stock item | Produto de stock | Itens de stock

○ Available under request | Disponível sobre consulta | Disponible bajo consulta

Note: Other dimensions available under request | Outras dimensões disponíveis sob consulta | Otras dimensiones disponibles bajo consulta

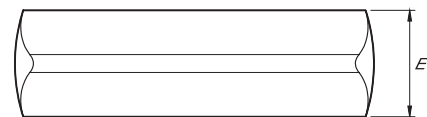
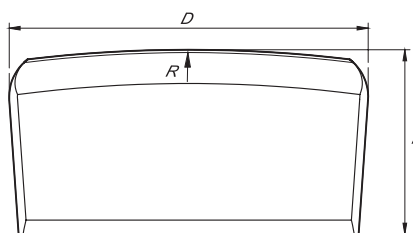
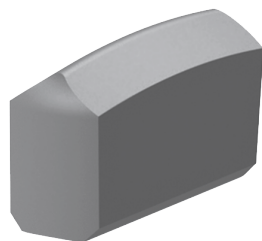

Order code Código de artigo Código producto	Reference Referência Referencia	Code Type Rúbrica artigo Tipo de código	Dimensions Dimensões Dimensiones				± Kg	Stock
			D (mm)	L (mm)	E (mm)	Radius (mm)		
139016433	ROCK D17x12x5 R80	3901	17,0	12,0	5,0	80	0,013	⊗
139019833	ROCK D18x12x5 R80	3901	18,0	12,0	5,0	80	0,014	⊗
139023233	ROCK D19x13x6 R80	3901	19,0	13,0	6,0	80	0,019	⊗
139016333	ROCK D20x13x6 R80	3901	20,0	13,0	6,0	80	0,020	⊗
139023313	ROCK D22x14x6 R50	3901	22,0	14,0	6,0	50	0,024	⊗
139011313	ROCK D23x14x6 R50	3901	23,0	14,0	6,0	50	0,024	⊗
139013713	ROCK D25,3x15,2x8,45 R70	3901	25,3	15,2	8,45	70	0,042	⊗
139013813	ROCK D26,3x15,2x8,45 R70	3901	26,3	15,2	8,45	70	0,043	⊗
139011413	ROCK D27,3x15,2x8,45 R70	3901	27,3	15,2	8,45	70	0,045	⊗
139011513	ROCK D28,3x15,2x8,45 R100	3901	28,3	15,2	8,45	100	0,046	⊗
139011613	ROCK D29,3x17,7x9,2 R100	3901	29,3	17,7	9,2	100	0,068	⊗
139011713	ROCK D30,3x17,7x9,2 R100	3901	30,3	17,7	9,2	100	0,063	⊗
139011813	ROCK D31,3x17,7x9,2 R100	3901	31,3	17,7	9,2	100	0,065	⊗
139011913	ROCK D32,3x17,7x10,18 R100	3901	32,3	17,7	10,18	100	0,073	⊗
139012013	ROCK D33,3x17,7x10,18 R100	3901	33,3	17,7	10,18	100	0,076	⊗
139012113	ROCK D34,3x17,7x10,18 R130	3901	34,3	17,7	10,18	130	0,079	⊗
139013913	ROCK D35,3x17,7x10,18 R130	3901	35,3	17,7	10,18	130	0,081	⊗
139014013	ROCK D36,3x17,7x10,18 R130	3901	36,3	17,7	10,18	130	0,095	⊗
139012213	ROCK D37,3x17,7x10,18 R130	3901	37,3	17,7	10,18	130	0,085	⊗
139012313	ROCK D38,3x17,7x10,18 R130	3901	38,3	17,7	10,18	130	0,087	⊗
139012413	ROCK D39,3x17,7x10,18 R130	3901	39,3	17,7	10,18	130	0,088	⊗
139012513	ROCK D40,3x17,7x10,18 R130	3901	40,3	17,7	10,18	130	0,092	⊗
139018413	ROCK D41,3x17,7x10,18 R130	3901	41,3	17,7	10,18	130	0,094	○
139014113	ROCK D42,3x17,7x10,18 R130	3901	42,3	17,7	10,18	130	0,096	○
139012613	ROCK D45,3x19,7x10,18 R160	3901	45,3	19,7	10,18	160	0,113	⊗

⊗ Stock item | Produto de stock | Itens de stock

○ Available under request | Disponível sobre consulta | Disponible bajo consulta

Note: Other dimensions available under request | Outras dimensões disponíveis sob consulta | Otras dimensiones disponibles bajo consulta

Inserts for Splitting Tools | Pastilhas para Lâminas | Plaquetas para Cuchillas

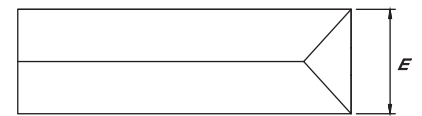
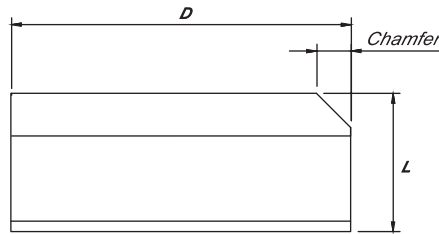
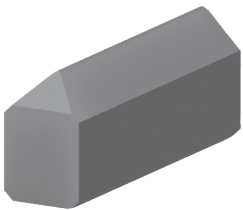
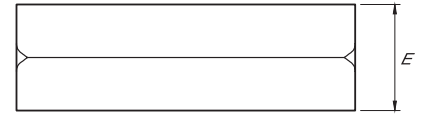
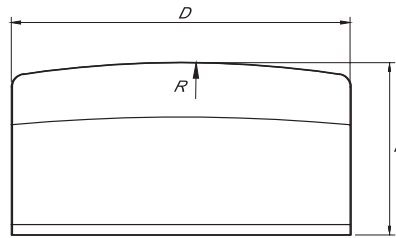
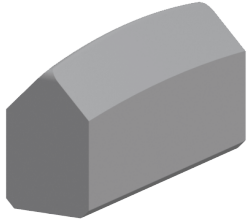

Order code Código de artigo Código producto	Reference Referência Referencia	Code Type Rúbrica artigo Tipo de código	Dimensions Dimensões Dimensiones					± Kg	Stock
			D (mm)	L (mm)	E (mm)	Radius (mm)	Chamfer		
1390034E5	LAMIN. 39,3x20x12 R125/90°	3901	39,3	20	12	125	no	0,117	☺
1390036E5	LAMIN. 48,8x20x13 R200/90°	3901	48,8	20	13	200	no	0,156	☺
1390079E5	LAMIN. 48,8x20x15 R125/90°	3901	48,8	20	15	125	no	0,172	☺
1390037E5	LAMIN. 49,5x20x13 90° C/CH	3901	49,5	20	13	0	yes	0,164	☺
1390039E5	LAMIN. 49,5x20x13 90° S/CH	3901	149,5	20	13	0	no	0,165	☺

☺ Stock item | Produto de stock | Itens de stock

○ Available under request | Disponível sobre consulta | Disponible bajo consulta

Note: Other dimensions available under request | Outras dimensões disponíveis sob consulta | Otras dimensiones disponibles bajo consulta



DRILLING EQUIPMENT

Drilling Equipment	Description Descrição Descripción	Page Página
	Integral Drill Rod H22 (7/8") Barrena H22 (7/8")	7 / 8
	Integral Drill Rod H19 (3/4") Barrena H19 (3/4")	9
	Integral Drill Rod H25 (1") Barrena H25 (1")	10
	Tapered Rod H22 (7/8") Barra Cónica H22 (7/8") Barra Cono H22 (7/8")	12
	Tapered Rod H25 (1") Barra Cónica H25 (1") Barra Cono H25 (1")	13
	Splitter 022 (7/8") Enraideira 022 (7/8") Barra de Rayar 022 (7/8")	15
	Splitter H22 (7/8") Enraideira H22 (7/8") Barra de Rayar H22 (7/8")	16
	Splitter Key Chave de Enraiar Clave de Rayar	17
	Mini Drill H22 (7/8") Barrena Torneada H22 (7/8")	19
	Mini Drill H19 (3/4") Barrena Torneada H19 (3/4")	19
	Shank Rod H22 (7/8") & H25 (1") Barra Roscada H22 (7/8") & H25 (1")	21
	Extension Rod H22 (7/8") & H25 (1") Barra Extensível H22 (7/8") & H25 (1") Barra Extensión H22 (7/8") & H25 (1")	23
	Coupling União Unión	25
	Thread Bit SB Bit de Rosca SB Boca de Rosca SB	27
Thread Bit DB Bit de Rosca DB Boca de Rosca DB	28	
Thread Bit XB Bit de Rosca XB Boca de Rosca XB	28	
Tapered Bit SB Bit Cónico SB Boca Cono SB	29	
Tapered Bit DB Bit Cónico DB Boca Cono DB	30	



SPLITTING TOOLS

Splitting Tools	Description Descrição Descripción	Page Página
	Top Splitting Tool with Lateral Slot with Radius Lâmina Superior em Raio com Rasgo Lateral Cuchilla Superior en Rayo con Rasgo Lateral	53
	Top Splitting Tool with Hole with Radius Lâmina Superior em Raio com Furo Cuchilla Superior en Rayo con Agujero	53
	Top Splitting Tool with Central Slot with Radius Lâmina Superior em Raio com Rasgo Central Cuchilla Superior en Rayo con Rasgo Central	54
	Top Splitting Tool with Slot or Hole without Radius Lâmina Superior Recta com Rasgo ou Furo Cuchilla Superior Recta con Rasgo o Agujero	54
	Bottom Splitting Tool without Hole and Radius Lâmina Base Recta sem Furos Cuchilla Base Recta sin Agujeros	55
	Bottom Splitting Tool without Hole with Radius Lâmina Base em Raio sem Furos Cuchilla Base en Rayo sin Agujeros	55
	Bottom Splitting Tool with 1 Hole with Radius Lâmina Base em Raio com 1 Furo Cuchilla Base en Rayo con 1 Agujero	56
	Bottom Splitting Tool with 2 Holes with Radius Lâmina Base em Raio com 2 Furos Cuchilla Base en Rayo con 2 Agujeros	56
	Bottom Splitting Tool with 3 Holes with Radius Lâmina Base em Raio com 3 Furos Cuchilla Base en Rayo con 3 Agujeros	57
	Bottom Splitting Tool with 5 Holes with Radius Lâmina Base em Raio com 5 Furos Cuchilla Base en Rayo con 5 Agujeros	57
	Bottom Splitting Tool with 4 Holes without Radius Lâmina Base Recta com 4 Furos Cuchilla Base Recta con 4 Agujeros	58
	Crush Tool Barmac Lâmina Raspa Barmac Cuchilla Raspa Barmac	58



FINISHING TOOLS

Finishing tools

Description Descrição Descripción	Page Página
Bush Hex. Square & Round with Buttons Bujarda Hexagonal Quadrada & Redonda com Pinos Bujarda Mango Cónico Fijo Cuadrada & Redonda con Botones	33
Bush Hex. Square with Blades Bujarda Hexagonal Quadrada com Lâminas Bujarda Mango Cónico Fijo Cuadrada con Láminas	33
Bush Shank Round with Buttons Bujarda Encabadoiro Redondo com Pinos Bujarda Mango Redondo con Botones	34
Bush Ballerina Square with Buttons Bujarda Bailarina Quadrada com Pinos Bujarda Bailarin Cuadrada con Botones	35
Bush Ballerina Square with Plate Bujarda Bailarina Quadrada com Placa Bujarda Bailarin Cuadrada con Placa	36
Bush Pellegrini Square with Buttons Bujarda Pellegrini Quadrada com Pinos Bujarda Pellegrini Cuadrada con Botones	37
Bush Pellegrini Round with Buttons Bujarda Pellegrini Redonda com Pinos Bujarda Pellegrini Redonda con Botones	38
Bush Pellegrini Square with Plate Bujarda Pellegrini Quadrada com Placa Bujarda Pellegrini Cuadrada con Placa	39
Bush Head with Buttons & Plate Cabeça de Bujarda com Pinos & Placa Cabeza de Bujarda con Botones & Placa	40
Bush "Vistas" Type Bujarda Tipo Vista	41
Hammer Picola	43
Chisel Bit Monoblock without Radius Cinzel Monoblock Recta sem Raio Cíncel Monoblock Recta sin Rayo	45
Chisel Bit Monoblock - Pneumatic Cinzel Monoblock Pneumático Cíncel Monoblock Neumático	46
Pitcher Escacilhador Escafilador	46
Stone Stamp with Hole Maço com Furo Maço con Agujero	48
Stone Stamp with Slot Maço com Rasgo Maço con Rasgo	48
Stone Hammer Maceta	50



INSERTS

Inserts

Description Descrição Descripción	Page Página
Inserts for Chainsaw Cutters Pastilhas para Serrotes Plaquetas para Sierras	61
Buttons for Bushes Pinos para Bujardas Botones para Bujardas	62
Plates for Bushes Placas para Bujardas	63
Inserts for Integral Drill Rods Pastilhas para Barrenas Plaquetas para Barrenas	64
Inserts for Splitting Tools Pastilhas para Lâminas Plaquetas para Cuchillas	65

Drilling Equipment

Finishing Tools

Splitting Tools

Inserts

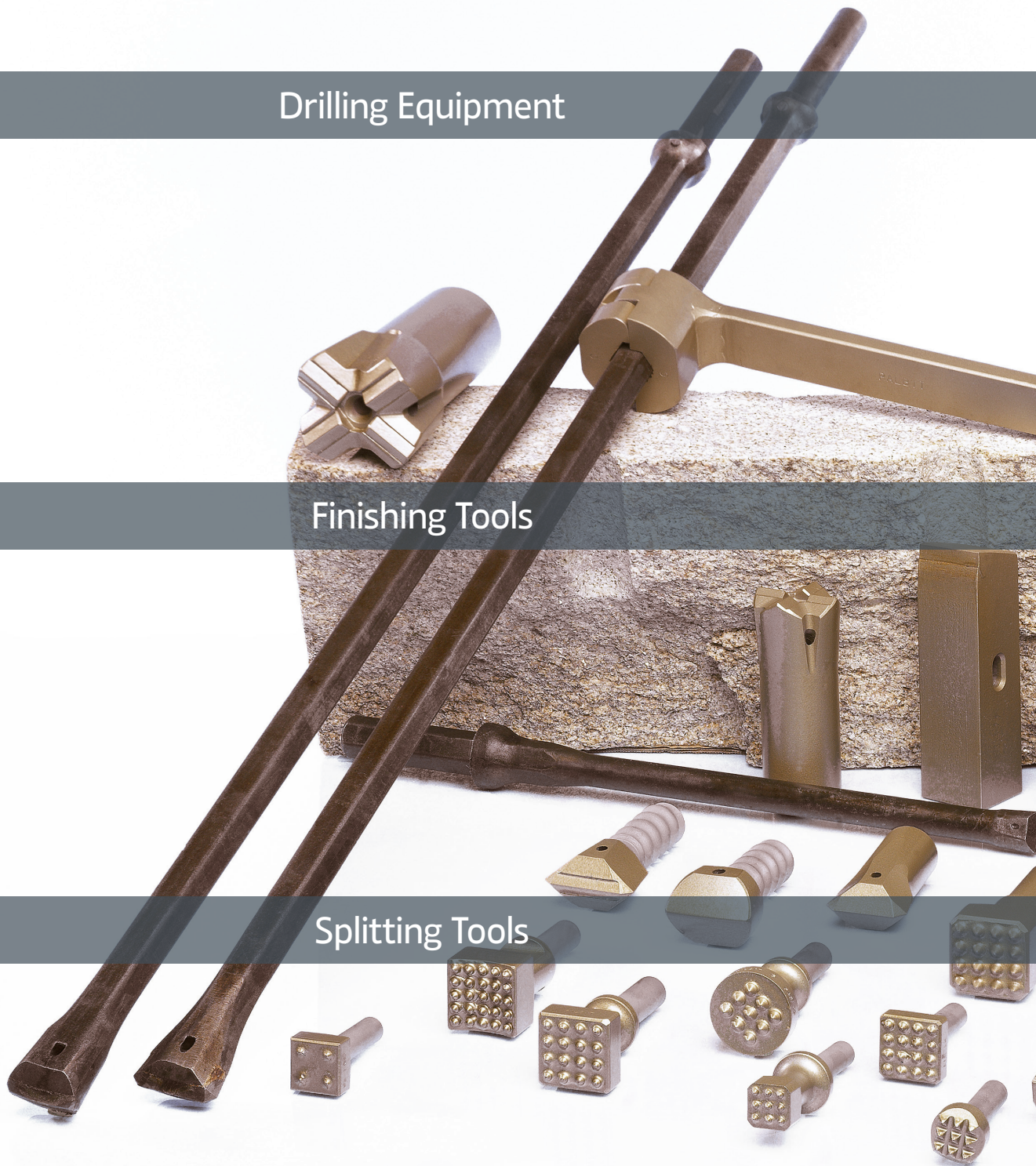



DRILLING
EQUIPMENT

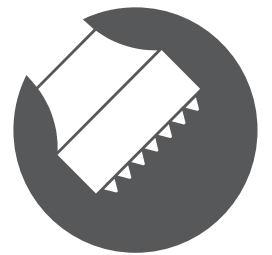

FINISHING
TOOLS



SPLITTING
TOOLS



INSERTS

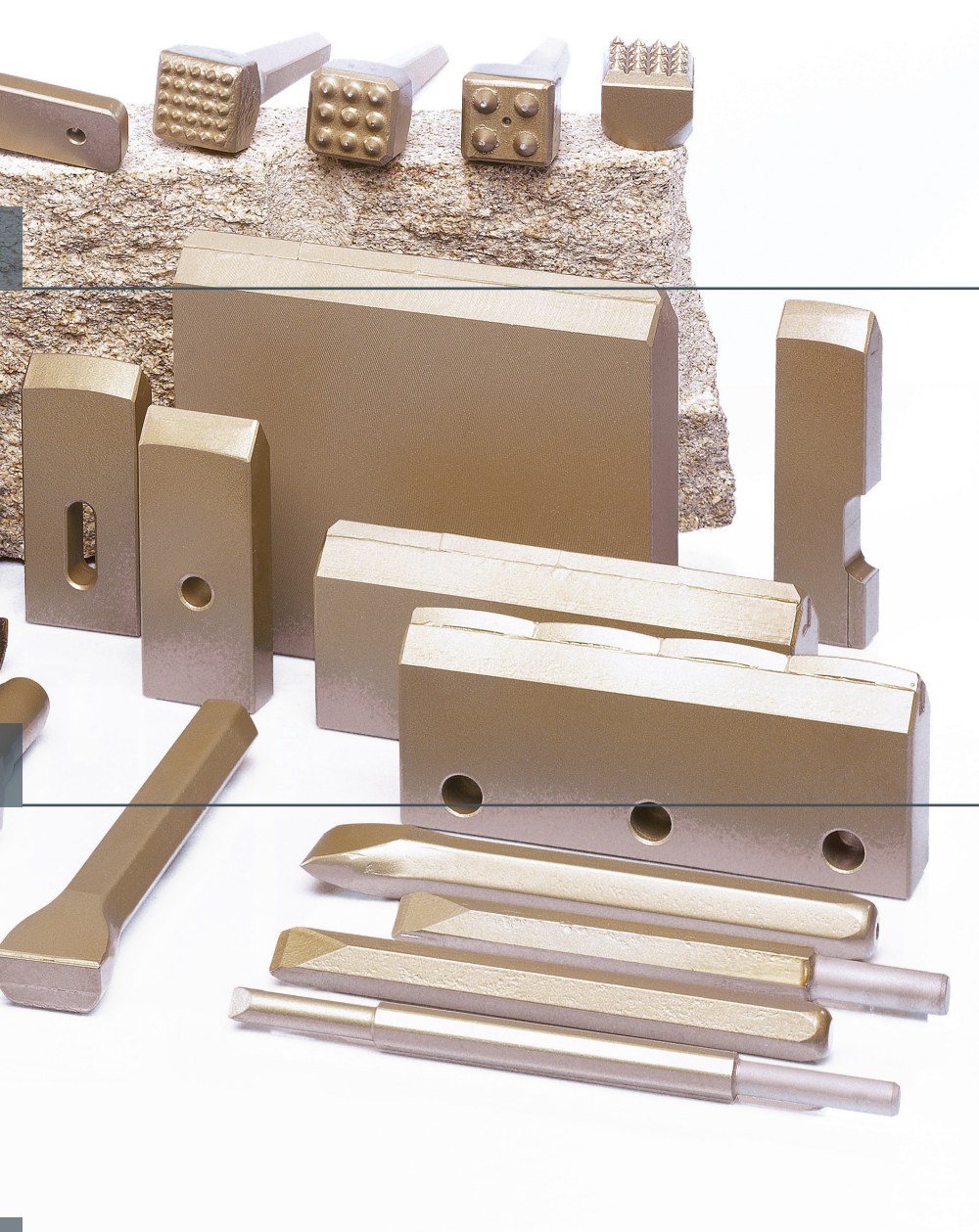

Rock Tools Catalogue

HEADQUARTERS

PALBIT, S.A.

P.O.Box 4 - Palhal

3854-908 - Branca ALB - Portugal

T (+351) 234 540 300 | F (+351) 234 540 301

palbit@palbit.pt

www.palbit.pt

Branch office:

PALBIT México

Emerson 150, Int.803-804, Colonia Chapultepec

Morales Delagación Miguel Hidalgo

C.P. 11570 México DF

T (+52) 5555 454 543 | F (+52) 5552 509 190

info@palbit.com.mx | www.palbit.com.mx

